

Welcome to the RGB/EGA/CGA/MDA to DVI(/VGA) Converter Family!

Thank you for purchasing an RGB to DVI(/VGA) Converter! We appreciate your business, and we think you'll appreciate the many ways that your enhanced RGB Graphic system will save you money, time, and effort.

That's because our RGB to DVI(/VGA) Converter is all about breaking away from the traditional model of attaching a new display to an old graphic source. You can encounter many potential problems in connecting a flat screen to an RGB graphic source – unless you use our RGB to DVI(/VGA) Converter products! Attach a flat screen to any graphic source and match the output to your requirements. The RGB to DVI(/VGA) Converter – the one-stop answer for all your RGB adapting needs! And with a special adaptor cable (not supplied as standard), you can also attach a screen to a CGA or EGA source.

And that's not all: With our RGB to DVI(/VGA) Converter you can also connect your monitor to the CGA, MDA or EGA graphic source.

This manual will tell you all about your new RGB to DVI(/VGA) Converter, including how to install, operate, and troubleshoot it. For an introduction to the Converter, see **Chapter 2**. The Converter product codes covered in this manual are:

K238-4F: RGB/EGA to DVI (or VGA) Converter

Copyrights and Trademarks

©2006. All rights reserved. This information may not be reproduced in any manner without the prior written consent of the manufacturer.

Information in this document is subject to change without notice and the manufacturer shall not be liable for any direct, indirect, special, incidental or consequential damages in connection with the use of this material.

All trademark and trade names mentioned in this document are acknowledged to be the property of their respective owners.

Disclaimer

While every precaution has been taken in the preparation of this manual, the manufacturer assumes no responsibility for errors or omissions. Neither does the manufacturer assume any liability for damages resulting from the use of the information contained herein. The manufacturer reserves the right to change the specifications, functions, or circuitry of the product without notice.

The manufacturer cannot accept liability for damage due to misuse of the product or due to any other circumstances outside the manufacturer's control (whether environmental or installation related). The manufacturer shall not be responsible for any loss, damage, or injury arising directly, indirectly, or consequently from the use of this product.

Cautions and Notes

The following symbols are used in this guide:



CAUTION. This indicates an important operating instruction that should be followed to avoid any potential damage to hardware or property, loss of data, or personal injury.



NOTE. This indicates important information to help you make the best use of this product.

EUROPEAN UNION DECLARATION OF CONFORMITY

This is to certify that, when installed and used according to the instructions in this manual, together with the specified cables and the maximum cable length <3m, the Units:

K238-4F

are shielded against the generation of radio interferences in accordance with the application of Council Directive 89/336/EEC as well as these standards:

EN 55022:	1999	Class A
EN 55024:	1999	
IEC 61000-4-2:	2001	
IEC 61000-4-3:	2001	
IEC 61000-4-4:	2001	
EN 61000-3-2	2001	
EN 61000-3-3	2002	

The device was tested in a typical configuration with PC.



Oberteuringen, Wednesday, October 21th, 2006

The management

A handwritten signature in black ink, appearing to read 'Peter Prigel'. The signature is written in a cursive style with a large, looped 'P' and 'S'.

This equipment has been found to comply with the limits for a Class A digital device, pursuant to Part 15 of the FCC Rules. These limits are designed to provide reasonable protection against harmful interference when the equipment is operated in a commercial environment. This equipment generates, uses, and can radiate radio frequency energy and, if not installed and used in accordance with the instruction manual, may cause harmful interference to radio communications. Operation of this equipment in a residential area is likely to cause harmful interference in which case the user will be required to correct the interference at his own expense.

Safety Precautions and Installation Guidelines

To ensure reliable and safe long-term operation, please note the following installation guidelines:

- Only use in dry, indoor environments.
- The Converter and any power supplies can get warm. Do not locate them in an enclosed space without any airflow.
- Do not place a power supply directly on top of a unit.
- Do not obstruct a unit's ventilation holes.



To safeguard against personal injury and avoid possible damage to equipment or property, please observe the following:

- **Only use power supplies originally supplied with the product or manufacturer-approved replacements. Do not attempt to dismantle or repair any power supply. Do not use a power supply if it appears to be defective or has a damaged case.**
- **Connect all power supplies to grounded outlets. In each case, ensure that the ground connection is maintained from the outlet socket through to the power supply's AC power input.**
- **Do not attempt to modify or repair this product**

Contents

1. Quick Setup	8
1.1 Video Input/Output	9
1.2 Command Summary	10
2. Overview	11
2.1 Introduction	11
2.2 Glossary	11
2.3 Features	14
2.4 Product Range	15
2.5 Compatibility	16
2.6 How to Use This Guide	17
3. Installation	18
3.1 Package Contents	18
3.2 Connection Cable Requirements	19
3.3 System Setup	20
3.4 Diagnostic LEDs	23
4. Device Control	24
4.1 Opening the OSD	25
4.2 Using the OSD	26
5. Monitor Setup	35
6. RGB to DVI(/VGA) Converter Setup	36
6.1 Overview	36
6.2 Setup Instructions for RGB Input	37
6.3 Setup of a new Video Mode	39
7. Troubleshooting	41
7.1 Video	41
Appendix A: Example Applications	43
Appendix B: Rack Mount Options	44

Appendix C: System Upgrade	46
Appendix D: Supported Video Modes	46
Appendix E: Calling Technical Support	50
Appendix F: Specifications	51
Appendix G: Connectors and Cables	52

1. Quick Setup

This section briefly describes how to install your RGB to DVI(/VGA) Converter and optimize the video signals. Unless you are an experienced user, we recommend that you follow the full procedures described in the rest of this manual. Refer to the command summary on page 10 when following this procedure.

Install system

1. Connect the RGB to DVI(/VGA) Converter to the RGB (video) source.
2. Connect a display to the RGB to DVI(/VGA) Converter.
3. Connect the DVI(/VGA) Converter to the Power supply
4. Power up the system.

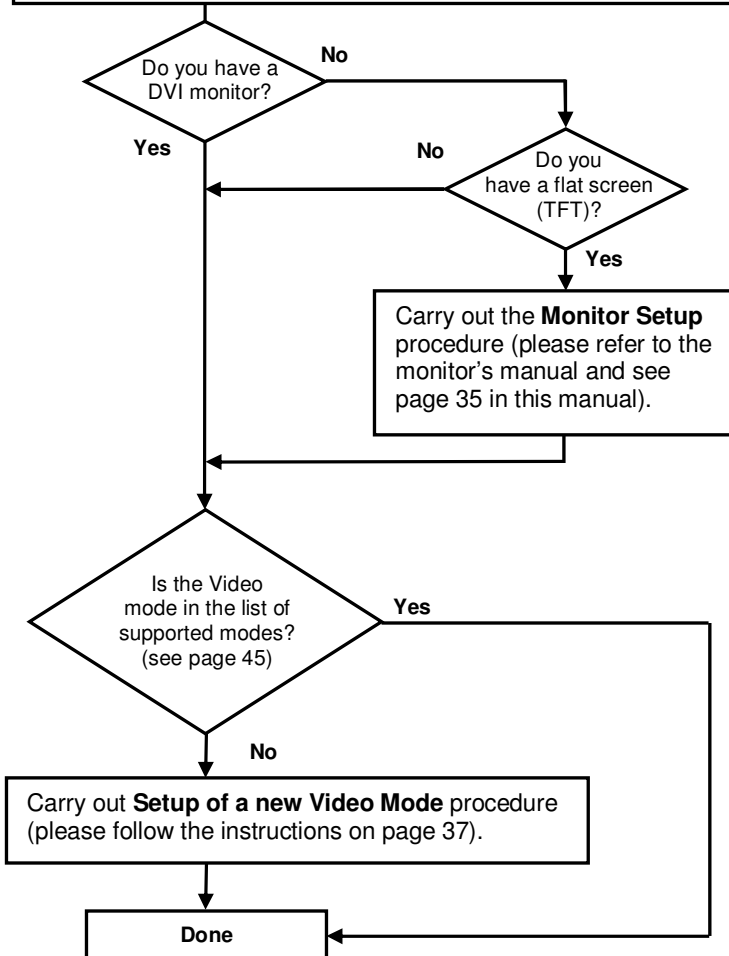

1.1 Video Input/Output

If possible, always use a DVI output to a monitor from the RGB to DVI(/VGA) Converter, especially with flat screens. This provides the optimum video signal. If you use a VGA output from the RGB to DVI(/VGA) Converter, it must convert the digitized data to analogue values. Similarly, if your TFT screen uses a VGA input, it must digitize the signal from the RGB to DVI(/VGA) Converter. In these cases, the built-in video processors (in the TFT) must determine the resolution and pixel phase for an optimized digitization. Your RGB to DVI(/VGA) Converter allows you to optimize the video signal manually or automatically using its on-screen utility (see **Chapter 4**). If you are using a VGA input to a TFT monitor, please follow the manufacturer's instructions.

You may have several possible options for video source output/monitor input. If this is the case, for the optimum video quality, please select the highest ranked available combination from the following table:

<i>Video Quality</i>	<i>RGB to DVI(/VGA) Converter input</i>	<i>RGB to DVI(/VGA) Converter output</i>
1	RGB progressive scan RGSB progressive scan	DVI/VGA
1	TTL (EGA/CGA/MDA)	DVI
2	RGB video (e.g. from SCART) interlaced	DVI/VGA
3	RGB progressive scan RGSB progressive scan	DVI/VGA
3	TTL (EGA/CGA/MDA)	VGA
4	RGB video (e.g. from SCART) interlaced	DVI/VGA

1.2 Command Summary

The following table summarizes the remote control buttons sequences used in system configuration and video tuning on the RGB to DVI(VGA) Converter.

Infrared Remote Control (IR-RC)

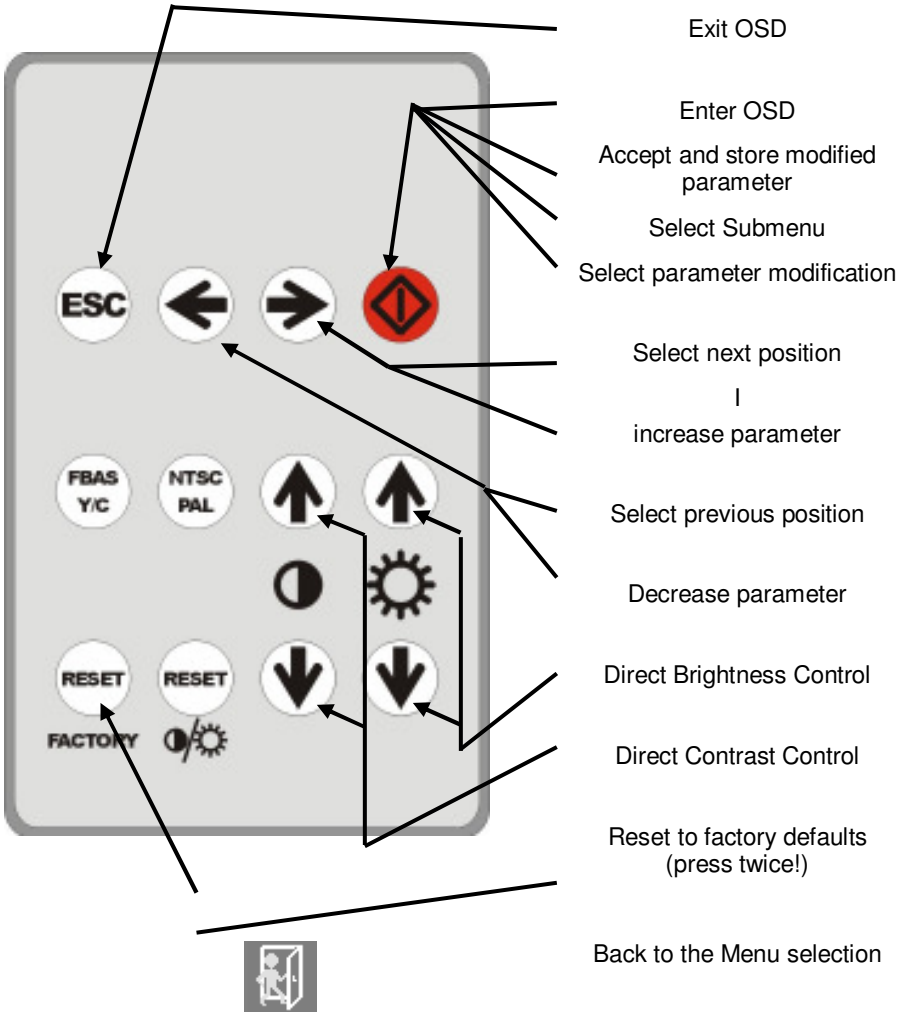

2. Overview

2.1 Introduction

VGA is the most familiar of the various graphics data standards or protocols for connecting a display (monitor or flat screen) to a graphic source. For many years, computers have generally connected to a display through a VGA interface. However, with the increased popularity of TFT flat screens, a new standard has been developed: DVI. In DVI, graphic data is transmitted digitally; VGA is an analogue standard.

Over the years, other analogue standards have also found popularity: CGA, EGA, MDA (=TTL) and also RGB. An RGB Video transmission consists of R (red), G (green) and B (blue) signals at a level of 0.7Vpp. The Green signal also carries the (composite) synchronisation signals.

A screen designed for VGA cannot normally display RGB/TTL signals for two reasons:

- A VGA screen requires H/V-Synchronization as TTL signals
- Many RGB/TTL sources generate HSYNC frequencies below of 30kHz – to slow for modern VGA displays.

With TFT screens, there is an additional problem: the incoming video signal has to be digitised. Horizontal and vertical resolutions are normally selected from an internal table with several, common, video modes. Unusual resolutions, often generated by older RGB graphic sources cannot be detected.

To display RGB/TTL data on a modern VGA or DVI display, the RGB to DVI(/VGA) Converter digitises the incoming signals, stores them in an internal video memory and displays them from there in a common resolution. The picture can be displayed in original size or format filling. The RGB to DVI(/VGA) Converter is equipped with various automatic and manual video correction tools in an on screen utility (see page 24).

2.2 Glossary

The following terms are used in this guide:

RGB	Video signal consisting of R (red) G (green) and B (blue) signals. The signals have a level of 0.7Vpp. The Green signal also carries the (composite) synchronisation signals.
RGBS	Video signal consisting of R (red) G (green) and B (blue) signals and the additional (composite) SYNC signal. All signals have 0.7Vpp.
CGA, EGA, MDA	Legacy graphic standard - all signals are TTL level.

THE RGB TO DVI(/VGA) CONVERTER

<i>VGA (also called RGBHV)</i>	Video signal consisting of R (red) G (green) and B (blue) signals and the additional horizontal/vertical synchronisation signals. The color signals have a level of 0.7Vpp; the synchronisation TTL (5Volts).
<i>DVI</i>	Digital Video standard established by the Digital Display Working Group (www.ddwg.org). R, G, B, CLOCK signals in an up to 1.4 Gbit/sec data stream. The signals have a TMDS level.
<i>PSU</i>	The desktop power supply for the RGB to DVI(/VGA) Converter.

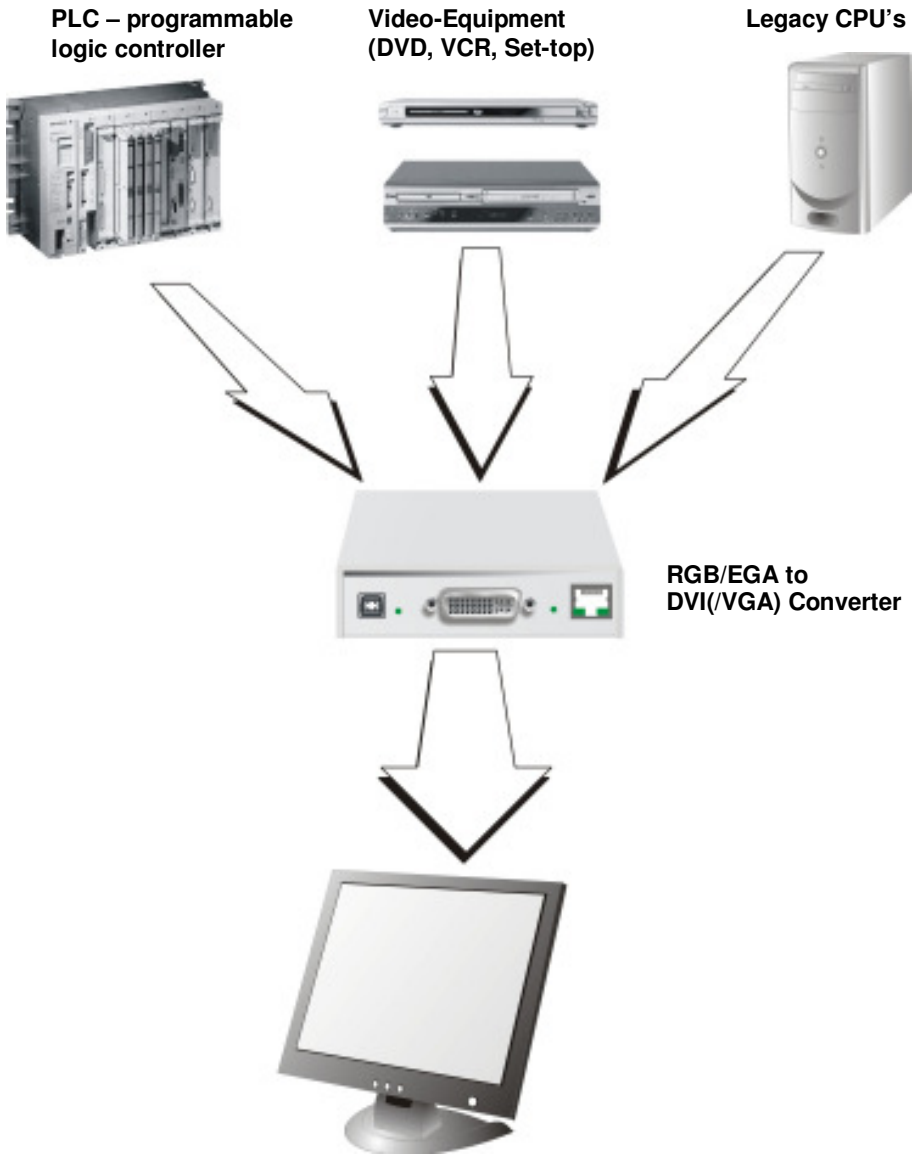

Figure 1 RGB to DVI(/VGA) Converter system

2.3 Features

RGB to DVI(/VGA) Converter offers the following features:

- Support for RGB, RGBS and RGBHV in progressive scan or interlaced mode.
- Support for EGS/CGA/MDA
- Selectable output for attached display: 640x480, 800x600, 1024x768, 1280x1024.
- Refresh rate selectable for best match to CRT or TFT – 50Hz, 60Hz or 75Hz.
- Picture scaling available:
 - *No scaling* – original picture is centered into a black box.
 - *Format filling* – the picture is stretched to fit the screen.
 - *Proportional stretching* – the picture is stretched linearly in both dimensions with the same factor, until one dimension fits the screen size.
 - *Fixed scaling* – scaled to 1:2 and displayed with (eventually) black borders.
- All control and video tuning carried out using an on screen display (OSD) with settings stored in EEPROM memory.
- A large table of known RGB resolutions (more than 80) preinstalled.
- Private video mode available through OSD.
- RGB to DVI(/VGA) Converter firmware and settings flash-upgradeable.
- Status indicator LEDs on each device.
- Small footprint chassis.
- Rack mount options available.
- Video cables and adaptors included.

Optional accessories:

- Rack mount Kit 19"/1U: Type 455-4G

2.4 Product Range

This table lists the product codes for the converter and its various upgrade kits:

RGB to DVI(/VGA) Converter

K238-3F	RGB to DVI (or VGA) Converter
---------	-------------------------------

Upgrade Kits

455-4G	19"/1U housing for up to 4 devices
--------	------------------------------------

455-1K	Mounting Plates (screw-fixed)
--------	-------------------------------

455-2K	Mounting Plate (snap-on)
--------	--------------------------

260-6H	Universal switch mode p.s.u. 90...230VAC/6VDC-2A
--------	--

2.5 Compatibility

Interface Compatibility

- **RGB:** Video signal consisting of R (red) G (green) and B (blue) signals. The signals have a level of 0.7Vpp. The Green-Signal also carries the (composite) synchronisation signals.
- **RGBS:** Video signal consisting of R (red) G (green) and B (blue) signals and the additional (composite) SYNC signal. All signals have 0.7Vpp.
- **VGA (also called RGBHV):** Video signal consisting of R (red) G (green) and B (blue) signals and additional horizontal/vertical synchronisation signals. The color signals have a level of 0.7Vpp; the synchronisation TTL (5Volts).
- **Digital Video (DVI):** DVI single link for resolution up to 1280x1024 at 60/75Hz. Digital Video standard established by the Digital Display Working Group (www.ddwg.org) R, G, B, CLOCK in an up to 1.4 Gbit/sec data stream. The signals have a TMDS level.
- **CGA (Colour Graphic Adaptor):** Legacy graphic standard, established by IBM, supporting text with 40 or 80 characters in 25 lines with 16 colours or graphics in 640x200 with 2 colours or 320x200 with 4 colours.
- **EGA:** Legacy graphic standard (Enhanced Graphic Adaptor), established by IBM, supporting text with 80 characters in up to 43 lines graphics in 640x350 in 16 colours from a palette of 64.

Supported SYNC forms

- **RGsB:** RGB with SYNC on Green. The colour signals have a level of 0.7Vpp. The Green-Signal also carries the (composite) synchronisation signals (app. – 0.3V)
- **RGBs:** RGB with composite SYNC signal. All signals have 0.7Vpp.
- **RGBS:** RGB with composite SYNC signal. The colour signals have 0.7Vpp, the SYNC signal is TTL-Level (5V)
- **RGBHV:** RGB with separate SYNC signals. The colour signals have 0.7Vpp, the SYNC Signals have TTL-Level (5V)
- **MDA:** black and white with separate SYNC signals (e.g. HERCULES). All Signals have TTL-Level (5V)
- **CGA:** colour with separate SYNC signals. All Signals have TTL-Level (5V)
- **EGA:** colour (2 pins per colour) with separate SYNC signals. All Signals have TTL-Level (5V)

2.6 How to Use This Guide

This guide describes the installation and configuration of the RGB to DVI(/VGA) Converter. Although the connection and operation of the system is relatively straightforward, you should consider the following before getting started:

Connection & Compatibility

If you have purchased an RGB to DVI(/VGA) Converter Kit, this will contain PSU and all the cables/adapters required to connect the RGB to DVI(/VGA) Converter to your graphic source. See also **Package Contents** (page 18)

For information about connection and installation, see **Installation**, page 18.

Adjusting the RGB to DVI(/VGA) Converter to RGB Video

Although there are several preconfigured resolutions stored in the internal resolution table of the RGB to DVI(/VGA) Converter, under some circumstances it is required to manually adapt the RGB to DVI(/VGA) Converter to your specific resolution: see **RGB to DVI(/VGA) Converter Setup** (page 36).

Adjusting the monitor to the RGB to DVI(/VGA) Converter

If you use a flat screen with VGA input, you will need to adjust the monitor to the picture width and the pixel phase. You can do this using the Auto Adjust or Manual Adjust procedures (see page 36).

- For experienced users there is a **Quick Setup** section at the start of this guide (see page 8).
- For the full procedure, see **Monitor Setup** (page 35) and/or **RGB to DVI(/VGA) Converter Setup** (page 36).

3. Installation

For first-time users, we recommend that you carry out a test placement, confined to a single room, before commencing full installation. This will allow you to identify and solve any cabling problems, and experiment with the RGB to DVI(/VGA) Converter more conveniently.

3.1 Package Contents

You should receive the following items in your RGB to DVI(/VGA) Converter package:

RGB to DVI(/VGA) Converter unit.

RGB(S) to DVI-I cable

6V DC 12W universal power supply for RGB to DVI(/VGA) Converter.

DVI-I to VGA adaptor (DVI-I dual link male to HD15 female) connector.

Data Cable DSUB9male- DSUB9female

Programming cable (DB9 female to RJ11 4p4c).

User manual (Quick Setup).

German-type power cord.

Infrared Remote Control (IR-RC)

If anything is missing, please contact Technical Support (see **Appendix E: Calling Technical Support**).

3.2 Connection Cable Requirements

To connect the RGB to DVI(/VGA) Converter to your graphic source you will need:

- **RGB(S):** 3 (4 with RGBS) coaxial cables type RG59B/U or similar, terminated with BNC connectors at the converters end. Please ensure that the connection is tension-free.
- **VGA:** Special VGA to DVI-I Cable HD15male-DVI-female
- **TTL:** Data Cable DSUB9male- DSUB9female
- **Power Supply**

Connect the supplied 6V/DC power supply to the **Plug** terminal on the rear of the RGB to DVI(/VGA) Converter.

3.3 System Setup

To install your RGB to DVI(VGA) Converter:

1. Switch off all devices.
2. Connect your TFT directly to the device; connect a VGA screen by using the equipped DVI-I to VGA adapter.



Attention: Connect the VGA monitor cable to the adapter; then plug in the adapter into the device. Otherwise, the VGA mode is not detected, DVI output is generated and there will be no picture on the screen (see also Diagnostic LEDs on page 23).



Under some circumstances, if your TFT supports both DVI and VGA through a DVI-I cable, it might be necessary to use an additional DVI-I to DVI-D adaptor to get a DVI output. Please contact technical support for this accessory.

3. **RGB:** Connect the graphic source to the input connectors as shown in Figure 14, using the equipped 4xBNC-to-DVI adaptor. Please note, for connecting a CGA or EGA source, connect the optional CGA-to-DVI adaptor or EGA-to-DVI adaptor instead of the 4x BNC-to-DVI adaptor.

VGA: Connect the graphic source to the input connectors as shown in Figure 4 using the VGA to DVI-I Cable which is an optional feature.

TTL: Connect the graphic source to the input connectors as shown in Figure 14, using the equipped Data Cable DSUB9male- DSUB9female.

4. Connect the 6V power supply to power the unit.



Only use the power supply originally supplied with this equipment or a manufacturer-approved replacement.

5. Power up the system.

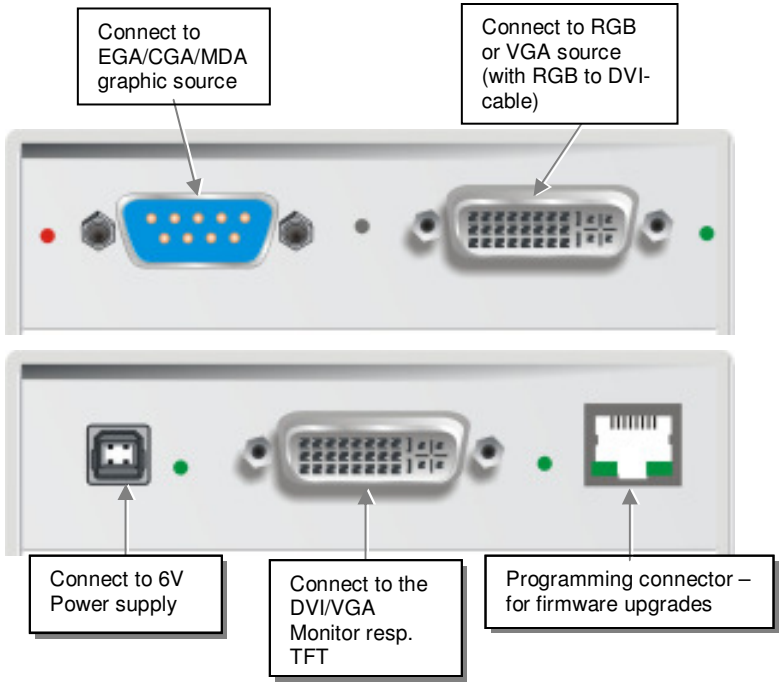
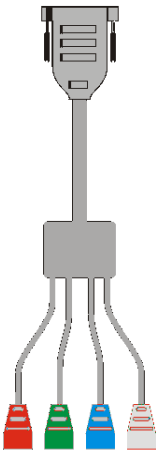

Figure 2 RGB to DVI(/VGA) Converter



THE RGB TO DVI(VGA) CONVERTER

Figure 3 RGB to DVI Cable (in list of parts)

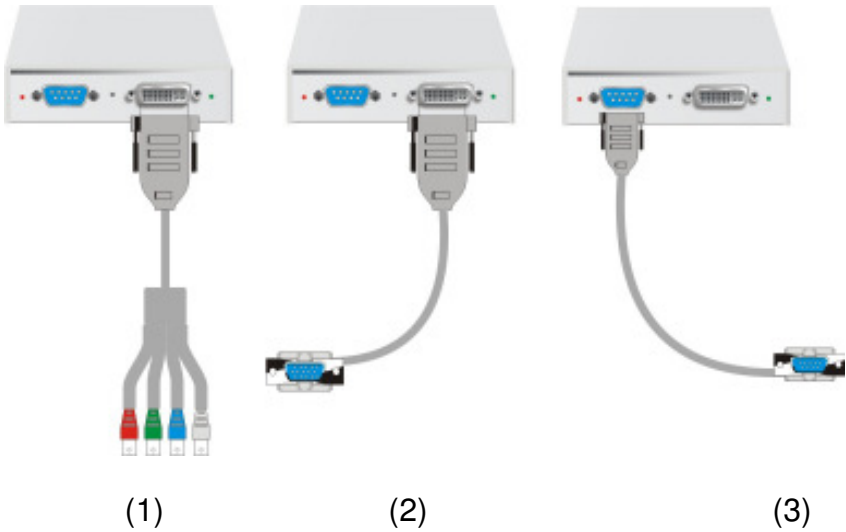

Figure 4 Connecting possibilities for RGB to DVI (1), VGA to DVI (2) and TTL to EGA, CGA and MDA (3) interface

Diagnostic LEDs

Each RGB to DVI(/VGA) Converter is fitted with four indicator LEDs: *Monitor Detect*, *Device Ready* and *Video Signal* and *Power*.

The *Monitor Detect* LED is to the right of the DVI output connector. The *Power* LED is to right of the power supply connector. The *Device Ready* is left to the EGA/CGA/MDA connector and *Video Signal* LEDs is right to the DVI Input connector.

The location of the LEDs is shown below:

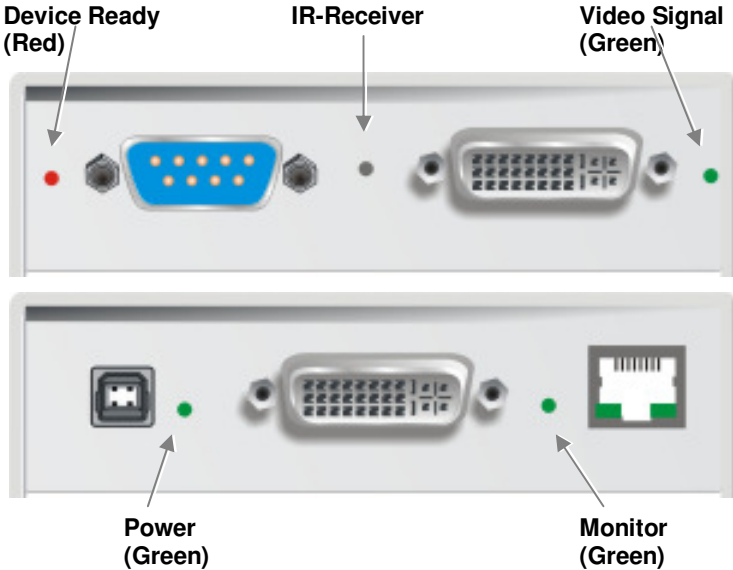

Figure 5 Diagnostic LEDs on RGB to DVI(/VGA) Converter

LED	Appearance	Diagnostics
Monitor Detect (Green LED)	On Flashing Off	Attached DVI monitor (TFT) detected Attached VGA monitor (CRT) detected No monitor detected
Device Ready (Red LED)	On Off	Device ready Device not ready
Video Signal (Green LED)	On Off	Attached and valid mode detected No video signal or valid mode detected
Power LED (Green LED)	On Off	Device ready Device not ready

4. Device Control

If you are using the CGA/EGA/MDA input or use an RGB format stored in the internal table, no adjustment should be required. In other cases, you may need to optimize the output using the RGB to DVI(VGA) Converter's on-screen display (OSD).

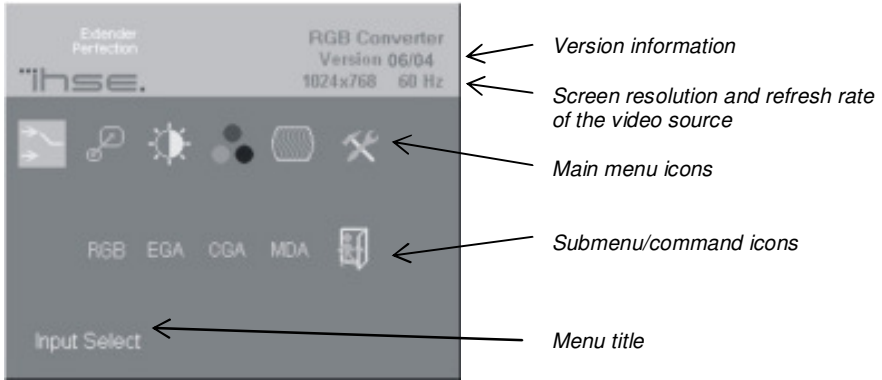

Figure 6 **OSD Utility**

You can adjust the following properties using the IR-Remote Control:

- Brightness/contrast
- Selection of Input Signal

You can adjust the following properties using the OSD:

- Auto Configuration ON/OFF
- Color, Color Temperature adjustments
- Brightness/contrast
- Input Image Sizing
- Output Image Scaling and Sizing
- Video Mode selection for similar Video Modes (see **Appendix D: Supported Video Modes** on page 46).
- OSD operation, factory reset.

4.1 Opening the OSD

You can access the OSD by using the equipped Infrared Remote Control (IR-RC).

Using the IR-RC

For direct brightness adjust For direct contrast adjust



more brightness

less brightness

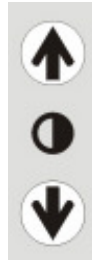

more contrast

less contrast

Reset to factory defaults



***Reset to factory defaults (from flash)
= resetting user presets
(press twice !!)***

To navigate within the OSD:



*exit OSD
without saving
values
(ESC key)*

*Navigate to
the left,
Parameter (-)
(left arrow
key)*

*Navigate to
the right
Parameter (+)
(right arrow
key)*

*pop up the OSD,
select function/
submenus,
store modified
parameter
(Enter-Key)*

4.2 Using the OSD

The OSD is an icon-based utility. The top line of symbols shows the main menu categories:



Input Select

Specify whether the input is RGB, RGBS, RGBHV (VGA), EGA, CGA, MDA



Scale Mode

Select the screen resolution of the attached display and select one of four scaling modes.



Brightness – Contrast

Adjust brightness or contrast or reset to default values.



Color

Adjust color calibration, temperature, flesh/skin tone, hue and saturation.



Image

Adjust pixel clock and phase. Define picture size and position.



Tools

Set OSD position and size, factory reset.

1. Use the left and right arrow to highlight the icon you want. The OSD displays additional icons relating to commands in the selected menu category.
2. Press the Enter key. The OSD highlights the first command icon.
3. Use the Left and Right arrow keys to highlight the command or submenu you want. In the case of the latter, your selection will cause the OSD to display additional command icons (Color Temperature commands, for example).
4. Press the Enter key to accept a highlighted command. If this requires the increase or decrease of a value (Contrast, for example), the OSD displays a value bar:





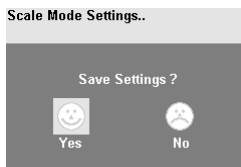

5. Use the Left and Right arrow keys to change the value as required.

6. In many cases, after you have chosen a new setting, the OSD displays the following confirmation message (or similar):



7. Highlight the *Yes* button and press the Enter key to confirm your choice. Alternatively, highlight the *No* button and press the Enter key to discard the new setting and restore the previous value.
8. Select the Exit icon to close a submenu.
9. Press the Esc key to close the OSD, saving all settings, and restore normal mouse and keyboard functions.

The following table summarizes the keyboard actions and icons used to navigate the OSD utility, and to select and adjust the RGB to DVI(VGA) Converter's parameters:

Key/Icon	Action
 IR-RC	Close the OSD, restore normal keyboard and mouse functions.
	Return to previous Menu selection.
	Open the highlighted menu or submenu Accept the highlighted command
	Select the previous menu or command icon Decrease the highlighted parameter
	Select the next menu or command icon Increase the selected parameter

THE RGB TO DVI(VGA) CONVERTER

Input Select (for future expansion)



Choose the type of the connectes graphic source

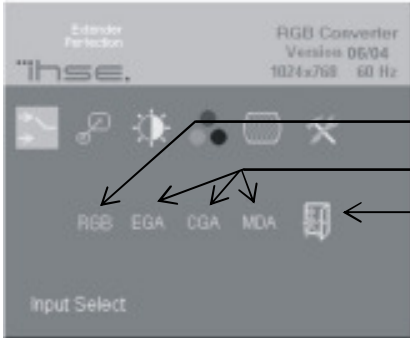

Select RGB, RGBS, RGBHV (VGA) source

RGB, CGA, MDA

Return to main menu

Figure 7 Input Select menu

Physical Resolution of attached screen



Use the Scale Mode menu to specify the physical resolution of the attached screen; this ensures the best matching pictures on a TFT screen. Use output scaling (see below) to stretch the picture to the maximum available screen space.

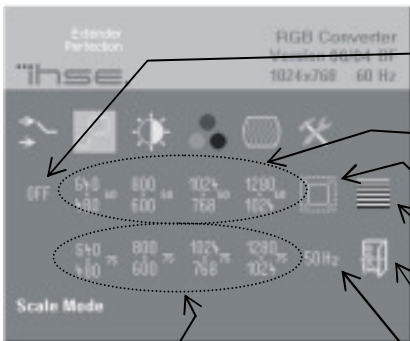

No change to the resolution/refresh: The output resolution/refresh rate is the same like the input resolution/refresh rate

Choice of four fixed screen resolutions at refresh rate of 60Hz (for LCD/flat screens) 640x480, 800x600, 1024x768, 1280x1024

Calling Output Scaling Sub-Menu

Select or Deselect line doubling for de-interlacing (video sources with interlaced signals only)

Return to main menu

Figure 8 Scale Mode menu

Choice of four fixed screen resolutions at refresh rate of 75Hz (for CRT/tube screens) 640x480, 800x600, 1024x768, 1280x1024

Select 50Hz Output-Mode for Video-Applications (resolution keeps unchanged – select before from Choice of four)

Output Scaling



Use the Output Scaling submenu to specify the best match between screen size and user requirements. Four modes are available:

1:1 – the picture is displayed with its original size and aspect ratio within a black frame. All pixels remain 1 wide and 1 high. Pictures with less than 300 lines are displayed in double height. Interlaced pictures are displayed in double height (deinterlaced)

OFF (Full screen) – The picture is stretched to fill all available screen space (non-proportional).

PROP (Proportional) – The picture is stretched (up scaling only!) to fill one screen dimension completely. The other dimension is made up with black borders (e.g. to keep a 16:9 ratio on scaling - proportional) Horizontal and vertical size of the screen must be both at least the size of the appropriate picture dimension.

1:2 – the picture is displayed at double the original size within a black frame. All pixels become 2 wide and 2 high. Horizontal and vertical size of the screen must be both at least the double size of the appropriate picture dimension.

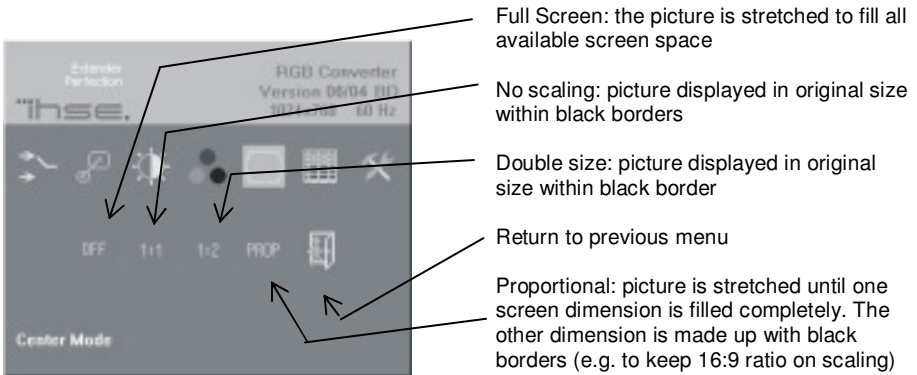

Figure 9 Output Scaling sub-menu

THE RGB TO DVI(VGA) CONVERTER

Brightness/Contrast



Use this menu to adjust the brightness and contrast of the video image, or to adjust the black level of a display.

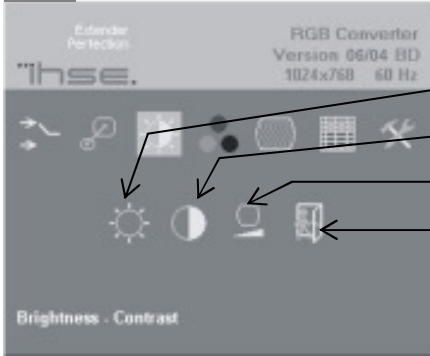

- Adjust Brightness
- Adjust Contrast
- Adjust Black level
- Return to main menu

Figure 10 Brightness-Contrast menu

Select Colors and Color Temperatures



Use the Colors menu to adjust the color balance of the video image. The menu provides a number of options including automatic calibration, manual adjustment in RGB or CMY color space, hue and saturation adjustment and the setup of flesh/skin tone.

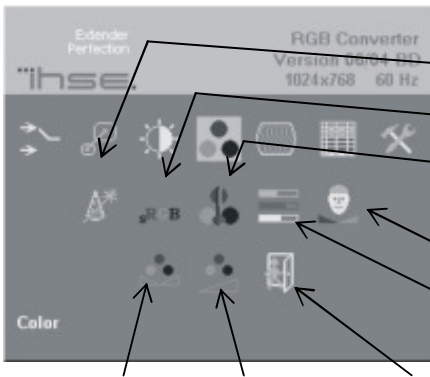

- Automatic color calibration
- Standard RGB color selection
- View Color temperature submenu (see **Color Temperature**, page 36)
- Flesh tone/Skin tone
- Set up colors in CMY space – automatically adjusts settings in RGB space

- Hue
- Saturation
- Back to main menu

Figure 11 Color menu

Color Temperature



Use the Color Temperature submenu to set up the color profile in RGB color space or by using one of five predefined color temperatures. To view this menu, select the Colors icon from the main menu and then select the Color Temperature icon.

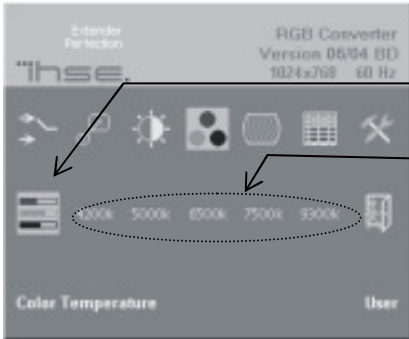

Set up colors in RGB space – automatically adjusts settings in CMY space

Choice of five color temperature settings: 4200k, 5000k, 6500k, 7500k, 9300k

Back to Color menu

Figure 12 Color Temperature sub-menu

Image



Use the Image menu to adjust the vertical and horizontal screen position, picture size and to set the pixel clock and phase. Doing some tunings on SYNC problems.

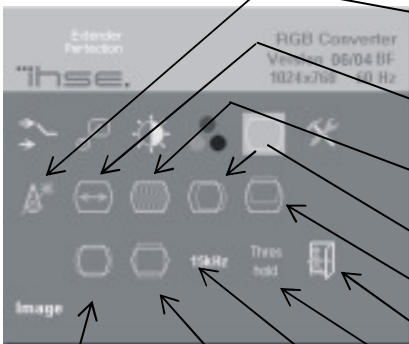

Automatic detection of the number of pixels per line and the best phase (best point for A/D conversion within each pixel) see also **RGB to DVI(/VGA) Converter Setup**, page 35.

Manually adjust the number of pixels per line (Pixel clock)

Manually adjust the best phase (best point for A/D conversion within each pixel)

Manually adjust the horizontal picture position

Manually adjust the vertical picture position

Back to main menu

Manually adjust the horizontal screen size (1:1 Mode only!)

Manually adjust the vertical screen size (1:1-Mode only!)

Select or deselect the threshold Checking on SYNC problems (see, page 40)

Select or deselect the 15kHz Glitch Filter on SYNC problems (see, page 40)

Figure 13 Image menu

THE RGB TO DVI(VGA) CONVERTER

Tools



Use the Tools menu to set the position and size of the OSD window, adjust the sharpness for a fixed resolution setting, reset the RGB to DVI(VGA) Converter system to its factory default settings or provide a test pattern.

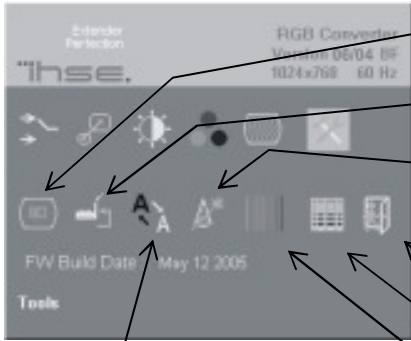

Set the position of the OSD window (see **OSD**, page 31)

Calling Factory Reset Sub-Menu

Choose whether to automatically adjust pixels per line and pixel phase after a mode change (see page 32)

Back to main menu

Calling Video-Modes Sub-Menu

Display a 'burst' pattern for monitor setup (see **Monitor Setup**, page 34)

Adjust sharpness (fixed resolution modes only). When resolution is changed by an imposed fixed resolution, sharpness can be affected. Use this option to switch between three settings for optimum sharpness

Figure 14 Tools menu

OSD



Use the OSD submenu to define the position and size of the OSD window. To view this menu, select the Tools icon from the main menu and then select the OSD icon.

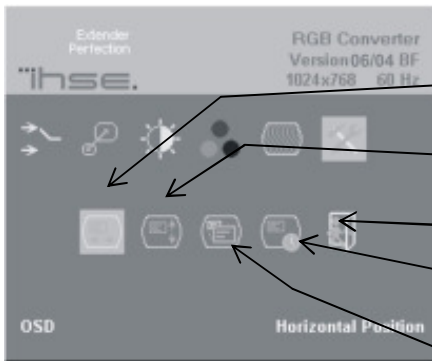

Manually adjust the horizontal position of the OSD window

Manually adjust the vertical position of the OSD window

Back to Tools menu

Choose OSD Timeout ON/OFF (ON – OSD will disappear after some seconds . OFF – OSD will keep alive until user closes)

Toggle the size of the OSD window between single and double size

Figure 15 OSD sub-menu

Factory Reset



Use the Factory Reset sub-menu to reset the unit to factory defaults, save user presets or restore user presets

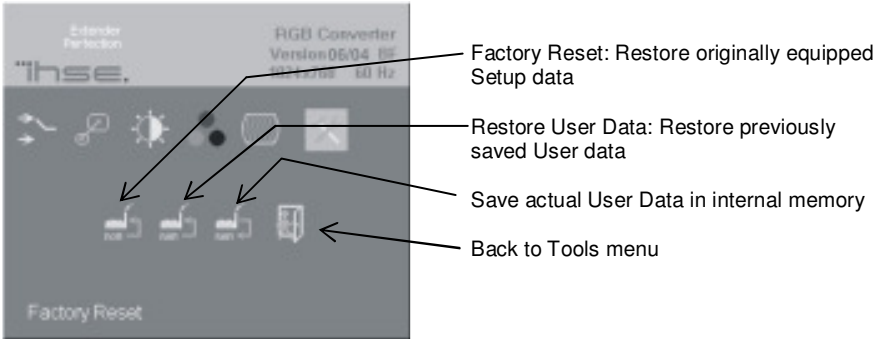

Figure 16 **Factory Reset sub-menu**

Auto Configuration



Use the Auto Configuration sub-menu to define whether the Converter carries out automatic detection of the number of pixels per line and the best phase after a mode change (a change of screen resolution and/or refresh rate at the graphic source). Using automatic detection (while displaying an appropriate test pattern) ensures an optimized image but the procedure introduces a delay in the picture appearing on the attached console screen. If you want the picture to appear as fast as possible, you may want to disable this feature. Auto Configuration is disabled in the default factory settings.

To view the Auto Configuration menu, select the Tools icon from the main menu and then select the Auto Configuration icon.

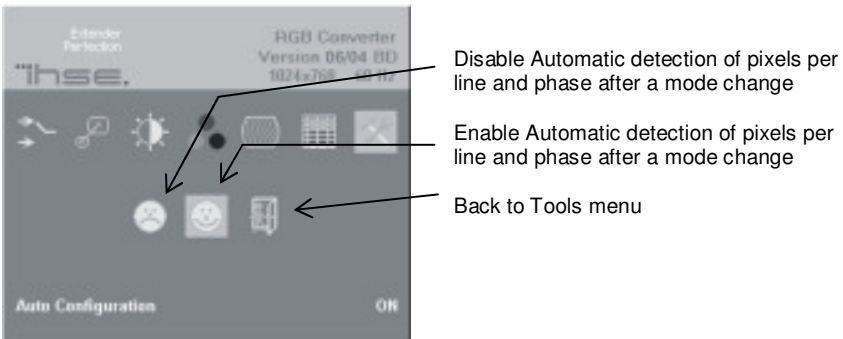

Figure 17 **Auto-Configuration sub-menu**

THE RGB TO DVI(VGA) CONVERTER

Video Mode



Use the Video Mode menu to select one of twelve Video Modes for a specific resolution. Please see (page 46) for more information about Video Modes and supported screen resolutions.

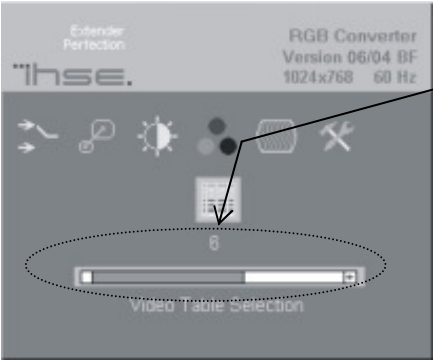

Choice of twelve different video modes. Please see also page 48

Figure 18 Video Mode menu

Color Filter

Most of the old graphic cards using only 8 or 27 colors, which means only the color levels of 0%, 50% and 100% (ref. 0V, 350mV, 700mV). Therefore a very strong noise could be on the signal, e.g. due to a bad power supply or a electromagnetical launching, which is noticeable especially as disturbing inhomogeneity on big areas in the picture. Using the color filter the input signals are defined on these three color levels, so that disturbing effects in the picture are corrected

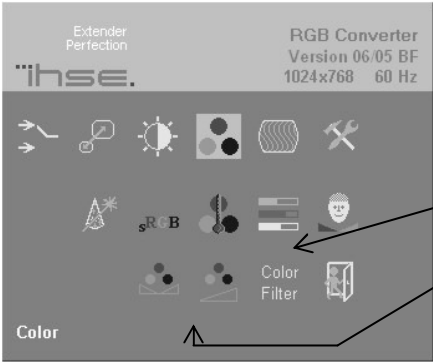

Execute the auto configuration in the color menu. Having a optimum color detection you should take a picture including many information (text, graphics, many colors).

Turn on the color filter

If there is still a noise in the picture, adjust it by setting up brightness and contrast.

5. Monitor Setup

This procedure is designed to correct for discrepancies in the video signal due to analogue/digital video conversion by the Monitor. You do not need to follow this procedure if you have:

- A CRT monitor connected to the RGB to DVI(/VGA) Converter through the VGA input
- A TFT monitor connected to the RGB to DVI(/VGA) Converter through the DVI input

In these cases, there is no need to adjust the monitor because the video format is not converted.

Please make sure that you carry out this procedure before setting up the RGB to DVI(/VGA) Converter (page 36). If you are using a TFT monitor at the RGB to DVI(/VGA) Converter with a VGA cable, the TFT monitor digitizes the video data stream and this may affect video quality. By setting up the TFT monitor first, you ensure that you are correcting discrepancies due solely to the RGB to DVI(/VGA) Converter system in the RGB to DVI(/VGA) Converter Setup procedure.

1. Connect the RGB to DVI(/VGA) Converter system and display the regular desktop in the desired screen resolution. Monitor Setup may vary depending on screen resolution and/or refresh rate.
2. Display the OSD utility (see page 25).
3. Select the Tools menu option (see page 32).
4. Select the 'burst' pattern option. Your TFT should show fine, 1 pixel wide, black and white vertical stripes over the entire screen. The OSD will stay visible in the middle of the screen.
5. Depending on the type of TFT, press the 'AUTO' Button on the monitor control panel or select *Auto Adjust* in the TFT Setup Menu. Refer to the manual supplied with your monitor for more information.
6. If the vertical stripes are sharp and without jitter or smearing, the adjustment has been successful. Go to step 8.
7. If the picture quality is not acceptable after the automatic adjustment, you will have to manually adjust the pixel clock and pixel phase (in this order). Please follow the instructions in your monitor's user manual.
8. Press any key to exit the test pattern display.
9. Exit the OSD.

6. RGB to DVI(/VGA) Converter Setup

6.1 Overview

You need to optimize the video signal across your RGB to DVI(/VGA) Converter system if it undergoes one or more conversions between analog and digital formats. The exact procedure depends on your RGB to DVI(/VGA) Converter setup:

<i>Graphics card</i>	<i>Monitor type</i>	<i>Monitor Input used</i>	<i>Video Optimization Procedure(s)</i>
RGB/ CGA/ EGA	TFT	VGA	TFT adjustment (see Monitor Setup , page 35) Optimization using OSD (see Setup Instructions for RGB Input , page 37)
RGB/ CGA/ EGA	CRT	VGA	Optimization using OSD (see Setup Instructions for RGB Input , page 37)
RGB/ CGA/ EGA	TFT	DVI	Optimization using OSD (see Setup Instructions for RGB Input , page 37)

6.2 Setup Instructions for RGB Input

This procedure is designed to correct for discrepancies in the video signal due to analogue/digital video conversion by the RGB to DVI(/VGA) Converter.

If you are using a TFT monitor at RGB to DVI(/VGA) Converter with a VGA cable, you should carry out the Monitor Setup procedure first (see page 35). In this configuration, the TFT digitize the video data stream and affect video quality. By setting up the TFT monitor, you ensure that you are correcting discrepancies due solely to the RGB to DVI(/VGA) Converter in this procedure. Alternatively, you could replace the TFT monitor with a CRT monitor while you carry out this procedure or use a TFT with DVI-cable. You can then reconnect the TFT monitor and optimize its video image afterwards.

1. Display from your graphic source a picture with as much detail as possible. If possible, display a 'burst-pattern' (see Figure 17) - a picture with alternating, 1-pixel wide, black and white, vertical stripes.

If you are unable to view the test card, display some black text on a white background. For example, you could open Notepad, maximize it to full screen, and fill the page with letter 'l's in a 12pt *sans serif* font. Proceed with step 2.

2. Display the OSD (see page 25).
3. Select the Image menu option:



4. Select the first command icon:
Automatic detection of number of pixels per line and the best phase.







5. Assess the desktop test pattern. If the vertical stripes are sharp and without jitter or smearing, the adjustment has been successful. Go to step 9.
6. If the picture quality is not acceptable after the automatic adjustment, you will have to manually adjust the pixel clock and pixel phase (in this order).
7. With a poorly adjusted pixel clock you may see one or more vertical areas, where the lines are smeared (see Figure 19a):

- a. Return to the OSD utility and select the menu command:
Manually adjust the number of pixels per line (Pixel clock) from the Image menu.



- b. Adjust the pixel clock value until all stripes have disappeared.
- c. Confirm the setting.

THE RGB TO DVI(VGA) CONVERTER

8. Problems with the pixel phase will cause horizontal noise, horizontal wave-formed lines, flicker or smearing with zebra-pattern (see Figure 19b):
 - a. From the OSD's Image menu, select the menu command: *Manually adjust the best phase (best point for A/D conversion with each pixel).* 
 - b. Modify the phase until all distortions have disappeared.
 - c. Confirm the setting.
9. If necessary adjust the size of the visible part of the picture. (The horizontal and vertical size is displayed in numeric value for exact adjustment)  
10. If necessary adjust the position of the visible part of the screen. It may be necessary to adjust the picture size (step 9) again  
11. If appropriate, re-attach your TFT monitor and adjust its image according to the manufacturer's instructions.

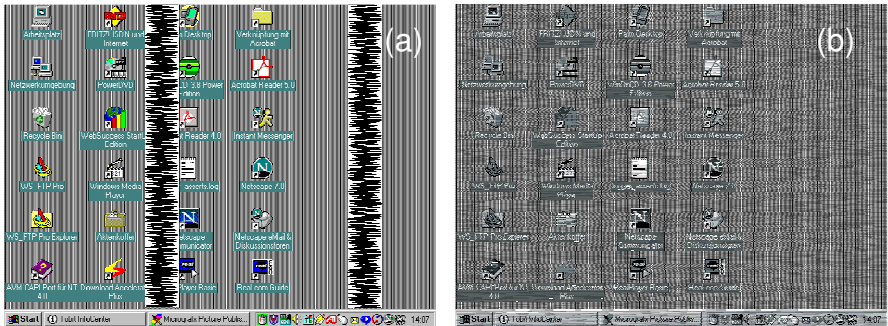



Figure 19 Burst test pattern applied to desktop showing problems with (a) pixel clock setting, (b) pixel phase setting.

6.3 Setup of a new Video Mode





The RGB to DVI(/VGA) Converter is preinstalled with several video modes and screen resolutions in various refresh rates suitable for using with an RGB source. If the mode generated by your RGB graphic source is not represented, you need to Setup a custom mode. The steps are similar to **6.2 Setup Instructions for RGB Input**. Your custom mode is stored automatically and can be used in the same way as the preinstalled modes.

1. Display from your graphic source a picture with as much detail as possible. If possible, display a 'burst-pattern' (see Figure 17) - a picture with alternating, 1-pixel wide, black and white, vertical stripes.

If you are unable to view the test card, display some black text on a white background. For example, you could open Notepad, maximize it to full screen, and fill the page with letter 'i's in a 12pt *sans serif* font. Proceed with step 2.

2. Display the OSD (see page 25).
3. Select the Scale Mode Menu (Physical Resolution of attached Screen – see page 29) and select the size of your used monitor (resolution must be equal or higher than the resolution, generated by your graphic card)
4. Select the Output Scaling Submenu (see page 30). Select *NO SCALING* – Mode (1:1)
5. Select the Video Mode Submenu (see page 35). Try-out all available modes and select the best matching one (all rows and all columns of your screen picture are displayed)
6. Select the Image menu option (see page 32)
7. Select the command icon:
Automatic detection of number of pixels per line and the best phase. 
8. The picture size may have been changed! Assess the desktop test pattern. If the vertical stripes are sharp and without jitter or smearing, the adjustment has been successful. Go to step 12.
9. If the picture quality is not acceptable after the automatic adjustment, you will have to manually adjust the pixel clock and pixel phase (in this order).
10. With a poorly adjusted pixel clock you may see one or more vertical areas, where the lines are smeared (see Figure 19a on page 39):
 - a. In the Image menu option (see page 32) select the command icon *Manually adjust the number of pixels per line (Pixel clock)* 
 - b. Adjust the pixel clock value until all stripes have disappeared.

THE RGB TO DVI(VGA) CONVERTER

- c. Confirm the setting.
11. Problems with the pixel phase will cause horizontal noise, horizontal wave-formed lines, flicker or smearing with zebra-pattern (see Figure 19b on page 39):
 - a. In the Image menu option (see page 32) select the command icon  *Manually adjust the best phase (best point for A/D conversion with each pixel).*
 - b. Modify the phase until all distortions have disappeared.
 - c. Confirm the setting.
12. If necessary, adjust the position of the visible part of the screen (Image menu option - see page 32)  
13. If necessary, adjust the size of the visible part of the picture. (The horizontal and vertical size is displayed in numeric values for exact adjustment).  
14. Select the Output Scaling Submenu (see page 30). Select the desired Scaling Mode
15. If appropriate, re-attach your TFT monitor and adjust its image according to the manufacturer's instructions.

7. Troubleshooting

7.1 Video

There isn't a picture.

Check the power supply connection at the RGB to DVI(/VGA) Converter. Is the *Device Ready* (Red LED) illuminated (see page 23)? If not, the internal power-supply may be damaged or there may be an internal error.

Check if the *Monitor detect* LED is illuminated (see page 23)? If not, there may be a problem with the Interconnection cable.

Check that you are using a supported video mode (see **Appendix D: Supported Video Modes**). At the RGB to DVI(/VGA) Converter, is the *Video Signal* LED illuminated (see page 23)? If not, do you need to Setup a new video mode?(see **Setup of a new Video Mode** on page 39)?

The green LED is blinking

This problem normally occurs only with RGB Signals if you have long coaxial cables, EMI noisy environment, high current power cables nearby or glitches from old graphic cards.

For Video Signals with HS< app. 20kHz, try to select 15kHz Glitch Filter to ON in Image Menu (Refer to page 32)

For Video Signals with HS> app. 20kHz, try to deselect Threshold Checking (OFF) in Image Menu (Refer to page 32)

After several seconds (minutes) intermittent loss of picture

This problem normally occurs only with RGB Signals if you have long coaxial cables, EMI noisy environment, high current power cables nearby or glitches from old graphic cards.

For Video Signals with HS< app. 20kHz, try to select 15kHz Glitch Filter to ON in Image Menu (Refer to page 32)

For Video Signals with HS> app. 20kHz, try to deselect Threshold Checking (OFF) in Image Menu (Refer to page 32)

I Can't access to the OSD because of intermittent loss of picture

Disconnect the input signals from the Video Source. Wait until the message „No Signal detected“ appears. Now you can access to the OSD and make your settings. After doing the setup, reconnect the signal source.

There is horizontal jitter on the picture.

The pixel clock and/or phase is misaligned: Refer to page 37.

Characters are smeared.

The phase is misaligned: Refer to page 37.

Thin vertical lines are missing.

The phase is misaligned: Refer to page 37.

No output to a connected CRT or TFT with VGA input.

First connect your VGA monitor cable to the adapter and then plug in the adapter to the device. Otherwise, the VGA mode is not detected, DVI output is generated and there is no picture on the screen (See also **Diagnostic LEDs** on page 23).

Alternatively do a power-cycle with the device, while the screen stays attached.

There are parts of the picture missing.

The picture size is incorrect: refer to page 39 (**Setup of a new Video Mode**).

Appendix A: Example Applications

This section illustrates some specific applications using the RGB to DVI(/VGA) Converter:

For more details, please discuss suitable converter architecture with Technical Support (see **Appendix E: Calling Technical Support**).



K238-4F
RGB to DVI(/VGA)
Converter attached to a
PLC

Figure 20 RGB to DVI(/VGA) Converter attached to a PLC



K238-4F
RGB to DVI(/VGA) Converter
attached to an old fashioned
Computer

Figure 21 RGB to DVI(/VGA) Converter with optional EGA/CGA support, attached to an old fashioned Computer

Appendix B: Rack Mount Options

RGB to DVI(/VGA) Converters can be mounted in a 19" rack using the mounting kit:
RGB to DVI (VGA) Rackmount Kit

This contains the following parts:

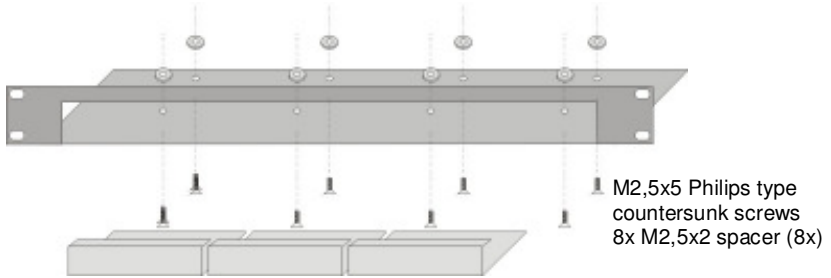

Figure 22 **Rack Mounting Kit**

To mount a unit:

1. Align the holes on the base plate with the vacant screw holes on the base of the RGB to DVI(/VGA) Converter unit.
2. Fasten the base of the unit to the plate of the mounting kit using the supplied screws.



Only use the supplied, short screws, to prevent damages on the PCB's

3. Close the remaining gaps with blanking plates.

APPENDIX B: RACK MOUNT OPTIONS

The kit allows you to mount a different count of devices
(1...4 devices):



Einbau 1 Gerät
mounting 1 device



Einbau 2 Geräte
mounting 2 devices



Einbau 3 Geräte
mounting 3 devices



Einbau 4 Geräte
mounting 4 devices

Appendix C: System Upgrade

System Update / Onboard Programming

It is occasionally necessary to update the firmware of the system. Normally, this procedure is carried out in the factory. If you want to update the firmware yourself, contact Technical Support. You will need a programming cable and software to carry out the update. Please follow the supplied instructions carefully.

Appendix D: Supported Video Modes

The following table shows the video modes originally supported by the Converter.

Mode	Identification	Hres	Vres	V-freq	H-freq	DotCLK
Selection		pixels	lines	Hz	kHz	MHz
3	MONA S5	442	416	54,4	24,3	14,0
0	AS 230 / 235 / OS 252	448	288	50,0	15,6	10,0
7	GBE 3977 - 64x32	448	288	50,0	15,6	10,0
4	DCC 555a	504	280	50,0	15,7	10,0
1	WF 470	512	240	49,1	15,6	12,0
2	WF 470 neu	512	245	50,1	15,6	12,0
1	WF 470 / AS 215	512	256	50,1	15,6	12,0
2	WF 470 / AS 215	512	512	50,0	31,3	24,0
5	GEM 80 graph i	560	224	50,0	15,6	11,8
5	GEM 80 graph i	560	224	60,0	15,8	11,8
5	GEM 80 graph i	560	224	75,0	18,2	12,0
8	GBE 3977 - 80x48	560	288	50,0	15,6	13,0
10	DISET - 80x25	560	288	50,0	15,6	12,2
12	DCS 560	560	288	50,0	15,7	11,4
1	MONA-C	560	413	58,2	25,8	20,0
5	GEM 80 graph progr.	560	448	50,0	31,3	23,5
5	GEM 80 graph progr.	560	448	60,0	31,5	23,7
5	GEM 80 graph progr.	560	448	75,0	36,4	24,0
2	WF 480	580	480	60,0	30,6	25,0

APPENDIX D: SUPPORTED VIDEO MODES

Mode	Identification	Hres	Vres	V-freq	H-freq	DotCLK
Selection		pixels	lines	Hz	kHz	MHz
0	CGA	640	200	60,0	15,8	14,2
6	CP526/527	640	234	50,1	15,4	13,1
6	GEM 80 text	640	288	48,8	15,6	13,0
1	Prokon 2	640	288	83,1	27,4	23,0
1	EGA (TTL)	640	350	59,9	21,9	16,3
2	DOS graphic Mode	640	350	70,0	31,4	25,1
0	Vesa Standard	640	350	85,0	37,9	31,5
1	IVE3	640	379	50,0	21,8	17,3
1	IVE4	640	385	50,0	20,0	16,1
1	ABB MOD 300	640	385	60,0	24,8	19,8
1	IVE2	640	398	50,0	21,9	17,8
0	VGA	640	400	56,0	24,6	20,9
1	OP 398 K	640	400	60,0	27,5	22,2
0	VGA	640	400	70,0	31,4	25,1
1	Vesa Standard	640	400	85,0	37,8	31,5
1	COROS LS-C	640	405	59,1	25,4	21,8
1	Prokon 1	640	432	53,8	25,5	23,0
1	Prokon 3	640	432	59,0	27,4	23,0
1	CP 526 highres. 50 Hz	640	468	50,0	31,2	26,2
1	CP 526 highres. 60 Hz	640	468	60,0	30,9	26,2
3	CP 528 highres. 60 Hz	640	468	60,0	30,9	28,3
1	WF 480 / Gracis	640	480	59,9	30,6	27,6
0	Vesa Standard	640	480	60,0	31,5	25,2
2	MAC Mode	640	480	66,7	35,0	31,4
0	Vesa Standard	640	480	72,8	37,9	31,5
0	Vesa Standard	640	480	75,0	37,5	31,5
0	Vesa Standard	640	480	85,0	43,3	36,0
1	NEC	642	200	60,0	15,0	13,5
1	Std.- VGA	656	496	59,9	31,5	25,2
4	NTSC (halfline)	680	240	60,0	15,7	12,9
3	NTSC Interlaced	720	240	60,0	15,8	13,5

THE RGB TO DVI(VGA) CONVERTER

Mode	Identification	Hres	Vres	V-freq	H-freq	DotCLK
Selection		pixels	lines	Hz	kHz	MHz
3	PAL Interlaced	720	288	50,0	15,6	13,5
1	ABB DSAV110	720	336	50,0	17,9	15,5
1	ABB DSAV111	720	336	61,2	21,8	19,7
1	Hercules monochrom	720	350	49,8	18,4	16,3
1	DOS Text Mode	720	400	70,0	31,4	28,3
2	Vesa Standard	720	400	85,0	37,9	35,5
2	VDU 2000 Coros	720	405	59,1	25,4	24,5
1	Teleperm / DS 078	720	408	60,0	25,7	23,1
3	NTSC progressive	720	480	60,0	31,5	27,0
3	PAL progressive	720	576	50,0	31,3	27,0
3	PC-Textmode	738	414	70,1	31,5	28,3
2	MTBI	746	246	60,0	15,7	14,1
2	CP 527/ 60	800	468	59,9	30,9	32,7
4	Vesa Standard	800	600	56,2	35,1	36,0
0	Vesa Standard	800	600	60,3	37,9	40,0
0	Vesa Standard	800	600	72,1	48,0	49,9
0	Vesa Standard	800	600	75,0	46,9	49,5
0	Vesa Standard	800	600	85,0	53,6	56,2
1	MAC Mode	832	624	75,0	49,5	55,4
0	Vesa Standard	1024	768	60,0	48,4	65,0
0	Vesa Standard	1024	768	70,0	56,4	74,9
1	SUN Mode	1024	768	72,0	58,0	75,2
0	Vesa Standard	1024	768	75,0	60,0	78,7
0	Vesa Standard	1024	768	85,0	68,7	94,5
2	Industrie Standard (I)	1024	768	87,0	35,5	44,9
11	DISET oversample	1120	288	50,0	15,6	24,5
1	DMT1185	1152	864	70,0	63,5	100,1
0	Vesa Standard	1152	864	75,0	67,5	108,0
1	SUN Mode	1152	900	66,7	62,5	95,5
9	GBE 3977 oversample	1164	288	50,0	15,6	26,0
1	1280 interlaced	1280	512	40,0	50,0	84,4

APPENDIX D: SUPPORTED VIDEO MODES

Mode	Identification	Hres	Vres	V-freq	H-freq	DotCLK
Selection		pixels	lines	Hz	kHz	MHz
1	TV Mode	1280	768	60,0	48,1	81,2
0	Vesa Standard	1280	960	60,0	60,0	108,0
1	DMT127A	1280	960	75,0	75,0	126,0
0	TV Mode	1280	1024	50,1	53,4	90,1
0	Vesa Standard	1280	1024	60,0	64,0	108,0
1	SUN Mode	1280	1024	66,7	71,7	117,0
1	SXGA Unix	1280	1024	73,0	77,2	131,0
0	Vesa Standard	1280	1024	75,0	80,0	135,0

Appendix E: Calling Technical Support

If you determine that your RGB to DVI(/VGA) Converter is malfunctioning, **do not attempt to alter or repair it**. It contains no user-serviceable parts. Contact Technical Support.

Before you do, make a record of the history of the problem. We will be able to provide more efficient and accurate assistance if you have a complete description, including:

- The firmware-revision level printed on the bottom of the RGB to DVI(/VGA) Converter (very important):

Version Number Format:

Board: *xxLO/RE Myyy Pzzz Auuu Gvvvvvv*
Firmware: *C/M/S xx Pyy Mzz*

- The nature and duration of the problem.
- When the problem occurs.
- The components involved in the problem—that is, what type of graphic source, what type, make and model of monitor, type and make of cable, etc.
- Any particular application that, when used, appears to create the problem or make it worse.
- The results of any testing you've already done.

To solve some problems, it might be necessary to upgrade the RGB to DVI(/VGA) Converter's firmware. If this turns out to be the case for your difficulty, our Technical Support technicians will arrange for you to receive the new firmware and will tell you how to install it.

Shipping and Packaging

If you need to transport or ship your RGB to DVI(/VGA) Converter:

- Package it carefully. We recommend that you use the original container.
- If you are shipping it for repair, please include the Unit's external power supply. If you are returning it, please include everything you received with it. Before you ship the RGB to DVI(/VGA) Converter back to your dealer for repair or return, contact him to get a Return Material Authorization (RMA) number.

Appendix F: Specifications

Power Requirements

Voltage	PSU: 90..240VAC-0.5A-47..63Hz/6VDC-2000 mA
Power required	RGB to DVI(/VGA) Converter: approx. 8W

Interface

Monitor	VGA (1280x1024@75Hz, plug&play supported) DVI (1280x1024@60Hz, plug&play supported)
Colour Depth	15 Bit for converting to DVI/VGA (5 Bit per colour)
Bandwidth	165 MHz
RGB/RGBS	0,7Vpp for color signals without Sync, 1Vpp for GREEN (with Sync), 0,7Vpp for composite Sync
RGBS	0,7Vpp for color signals and Sync
CGA/EGA/MDA	TTL for colours and Sync

Size and Shipping Weight

RGB to DVI(/VGA) Converter	4.0"x5.6"x1.1" (103x143x29mm) Gewicht: 0.55lb (0.25kg)
Shipping box	18.1"x9.8"x4.7" (210x150x165mm) Gewicht: 3.5lb (1.6kg)

Environmental

Operating Temperature	41 to 113°F (5 to 45 °C)
Storage Temperature	-13 to 140°F (-25 to 60 °C)
Relative Humidity	max. 80% non-condensing

Appendix G: Connectors and Cables

RGB to DVI(VGA) Converter Connector Pinouts

DVI-I Female connector (for Input and Output)

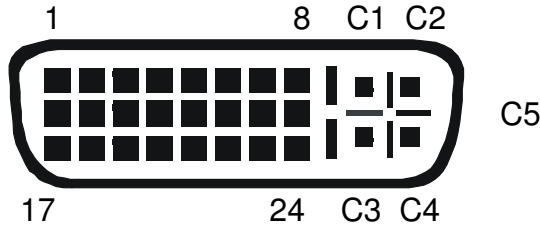

<i>Pin</i>	<i>Signal</i>	<i>Pin</i>	<i>Signal</i>	<i>Pin</i>	<i>Signal</i>
1	T.M.D.S data 2-	9	T.M.D.S data 1-	17	T.M.D.S data 0-
2	T.M.D.S data 2+	10	T.M.D.S data 1+	18	T.M.D.S data 0+
3	T.M.D.S data 2 GND	11	T.M.D.S data 1 GND	19	T.M.D.S data 0 GND
4	n.c.	12	n.c.	20	n.c.
5	n.c.	13	n.c.	21	n.c.
6	DDC Input (SCL)	14	+5V Power	22	T.M.D.S clock GND
7	DDC Output(SDA)	15	GND	23	T.M.D.S clock +
8	Analog VSYNC	16	Hot Plug recognition	24	T.M.D.S clock -
C1	Analog Red			C3	Analog Blue
C2	Analog Green	C5	Analog GND	C4	Analog HYSNC

Programming

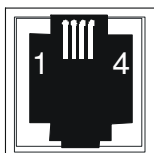

<i>Pin</i>	<i>Signal</i>
1	TxD (to PC RxD)
2	RxD (from PC TxD)
3	DTR from PC
4	GND

Power

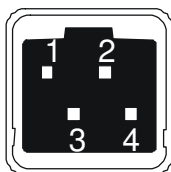

<i>Pin</i>	<i>Signal</i>
1	GND
2	Earth
3	n.c.
4	+6VDC
Housing	Shield

THE RGB TO DVI(VGA) CONVERTER

EGA/CGA/MD-Buchse (für TTL-Eingang)

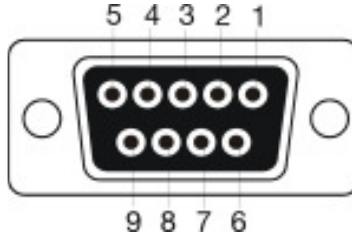

<i>Pin</i>	<i>EGA</i>	<i>CGA</i>	<i>MDA</i>
1	Ground (GND)	Ground (GND)	Ground (GND)
2	Red (LSB)		
3	Red (MSB)	Red	
4	Green (MSB)	Green	
5	Blue (MSB)	Blue	
6	Green (LSB)	Intensity	Intensity
7	Blue (LSB)		Video
8	H-SYNC	H-SYNC	H-SYNC
9	V-SYNC	V-SYNC	V-SYNC

Adapter Cables

DVI/VGA Adapter

RGB to DVI(/VGA) Converter:
DVI-I male connector

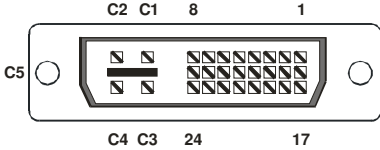

<i>Pin</i>	<i>Signal</i>
6	DDC Input (SCL)
7	DDC Output(SDA)
8	Analog VSYNC
C1	Analog Red
C2	Analog Green
C3	Analog Blue
C4	Analog HYSNC
C5	Analog GND

Monitor:
HD15 female connector

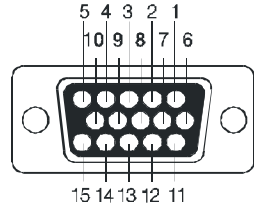

<i>Pin</i>	<i>Signal</i>
15	DDC Input (SCL)
12	DDC Output (SDA)
14	Analog VSYNC
1	Analog Red
2	Analog Green
3	Analog Blue
13	Analog HSYNC
6,7,8	Analog GND