

Welcome to the DDXI DVI/VGA KVM Extender Family!

Thank you for purchasing a DDXI DVI/VGA KVM Extender model! We appreciate your business, and we think you'll appreciate the many ways that your enhanced keyboard/video/mouse system will save you money, time, and effort.

That's because our DDXI DVI/VGA KVM Extender family is all about breaking away from the traditional, expensive model of computer management. You know the one-size-fits-all-even-if-it-doesn't model that says, "One computer gets one user station, no more, no less." Why not a pair of user stations, each of which can control multiple computers? Why not multiple user stations for the same computer?

With our DDXI DVI/VGA KVM Extender products, there's no reason why not. We carry a broad line of robust solutions for all these applications. The DDXI DVI/VGA KVM Extender family—the one-stop answer for all your KVM-extending needs!

This manual will tell you all about your new DDXi DVI/VGA KVM Extender, including how to install, operate, and troubleshoot it. For an introduction to the Extender, see **Chapter 2**. The Extender product codes covered in this manual are:

K439-0W: DDXi DVI/VGA KVM Extender over Cat5 – DVI/VGA only

K439-1W: DDXi DVI/VGA KVM Extender over Cat5 – PS/2

K437-0W: DDXi DVI/VGA KVM Extender over Multimode Fibre – DVI/VGA only

K437-1W: DDXi DVI/VGA KVM Extender over Multimode Fibre – PS/2

K438-0W: DDXi DVI/VGA KVM Extender over Singlemode Fibre – DVI/VGA only

K438-1W: DDXi DVI/VGA KVM Extender over Singlemode Fibre – PS/2

K442-2U: DDXi DVI/VGA KVM Extender over Multimode Fibre – USB

K443-2U: DDXi DVI/VGA KVM Extender over Singlemode Fibre – USB

Copyrights and Trademarks

©2006. All rights reserved. This information may not be reproduced in any manner without the prior written consent of the manufacturer.

Information in this document is subject to change without notice and the manufacturer shall not be liable for any direct, indirect, special, incidental or consequential damages in connection with the use of this material.

All trademark and trade names mentioned in this document are acknowledged to be the property of their respective owners.

Disclaimer

While every precaution has been taken in the preparation of this manual, the manufacturer assumes no responsibility for errors or omissions. Neither does the manufacturer assume any liability for damages resulting from the use of the information contained herein. The manufacturer reserves the right to change the specifications, functions, or circuitry of the product without notice.

The manufacturer cannot accept liability for damage due to misuse of the product or due to any other circumstances outside the manufacturer's control (whether environmental or installation related). The manufacturer shall not be responsible for any loss, damage, or injury arising directly, indirectly, or consequently from the use of this product.

Cautions and Notes

The following symbols are used in this guide:



CAUTION. This indicates an important operating instruction that should be followed to avoid any potential damage to hardware or property, loss of data, or personal injury.



NOTE. This indicates important information to help you make the best use of this product.

EUROPEAN UNION DECLARATION OF CONFORMITY

This is to certify that, when installed and used according to the instructions in this manual, together with the specified cables and the maximum cable length <3m, the Units:

K439-0W, K439-1W
K437-0W, K437-1W
K438-0W, K438-1W
K442-2U, K443-2U

are shielded against the generation of radio interferences in accordance with the application of Council Directive 89/336/EEC as well as these standards:

EN 55022:	1999	Class A
EN 55024:	1999	
IEC 61000-4-2:	2001	
IEC 61000-4-3:	2001	
IEC 61000-4-4:	2001	
EN 61000-3-2	2001	
EN 61000-3-3	2002	

The device was tested in a typical configuration with PC.



Oberteuringen, Wednesday, October 21th, 2006

The management

A handwritten signature in black ink, appearing to read 'Peter Prigel'. The signature is written in a cursive style with a large, looped 'P'.

This equipment has been found to comply with the limits for a Class A digital device, pursuant to Part 15 of the FCC Rules. These limits are designed to provide reasonable protection against harmful interference when the equipment is operated in a commercial environment. This equipment generates, uses, and can radiate radio frequency energy and, if not installed and used in accordance with the instruction manual, may cause harmful interference to radio communications. Operation of this equipment in a residential area is likely to cause harmful interference in which case the user will be required to correct the interference at his own expense.

Safety Precautions and Installation Guidelines

To ensure reliable and safe long-term operation, please note the following installation guidelines:

- Do not use CATx-devices to link between buildings – please use fiber devices.
- Only use in dry, indoor environments.
- If the building has 3-phase AC power, try to ensure that equipment connected to the Local and Remote units is on the same phase.
- Try not to route a CATx link cable alongside power cables.
- Ensure that the system connected to the Local unit is connected to power ground.
- Ensure that the monitor connected to the Remote unit is connected to power ground and does not use an isolated power supply.
- The Remote unit, Local unit and any power supplies can get warm. Do not locate them in an enclosed space without any airflow.
- Do not place a power supply directly on top of a unit.
- Do not obstruct a unit's ventilation holes.



To safeguard against personal injury and avoid possible damage to equipment or property, please observe the following:

- **Only use power supplies originally supplied with the product or manufacturer-approved replacements. Do not attempt to dismantle or repair any power supply. Do not use a power supply if it appears to be defective or has a damaged case.**
- **Connect all power supplies to grounded outlets. In each case, ensure that the ground connection is maintained from the outlet socket through to the power supply's AC power input.**
- **Do not attempt to modify or repair this product, or make a connection from the CATx link interface (RJ45) or the Fiber link interface (SC-Duplex) to any other products, especially telecommunications or network equipment.**



- **To comply with CE regulations, it is NOT allowed, to use CATx devices with unshielded CATx cables**

Contents

1. Quick Setup	8
1.1 Video Input/Output	9
1.2 Command Summary	10
2. Overview	11
2.1 Introduction	11
2.2 Glossary	11
2.3 Features	13
2.4 Product Range	14
2.5 Compatibility	15
2.6 How to Use This Guide	16
3. Installation	17
3.1 Package Contents	17
3.2 Interconnection Cable Requirements	18
3.3 System Setup	19
3.4 Diagnostic LEDs	23
3.5 Access Switching	24
3.6 Private Mode	24
4. Device Control	25
4.1 Opening the OSD	26
4.2 Using the OSD	28
5. Monitor Setup	36
6. Extender Setup	37
6.1 Overview	37
6.2 Setup Instructions for VGA Input	38
7. Troubleshooting	40
7.1 Video	40
7.2 Keyboard & Mouse	41
Appendix A: Example Applications	42

Appendix B: Rack Mount Options	46
Appendix C: System Upgrade & Dual Access	48
Appendix D: Video Modes and Frame Rates	49
Appendix E: USB – High Power/Low Power	51
Appendix F: Audio/Serial Upgrade	52
Appendix G: Calling Technical Support	54
Appendix H: Specifications	55
Appendix I: Connectors and Cables	58

1. Quick Setup

This section briefly describes how to install your DDXI DVI/VGA KVM-Extender and optimize the video signals. Unless you are an experienced user, we recommend that you follow the full procedures described in the rest of this manual. Refer to the command summary on page 10 when following this procedure.

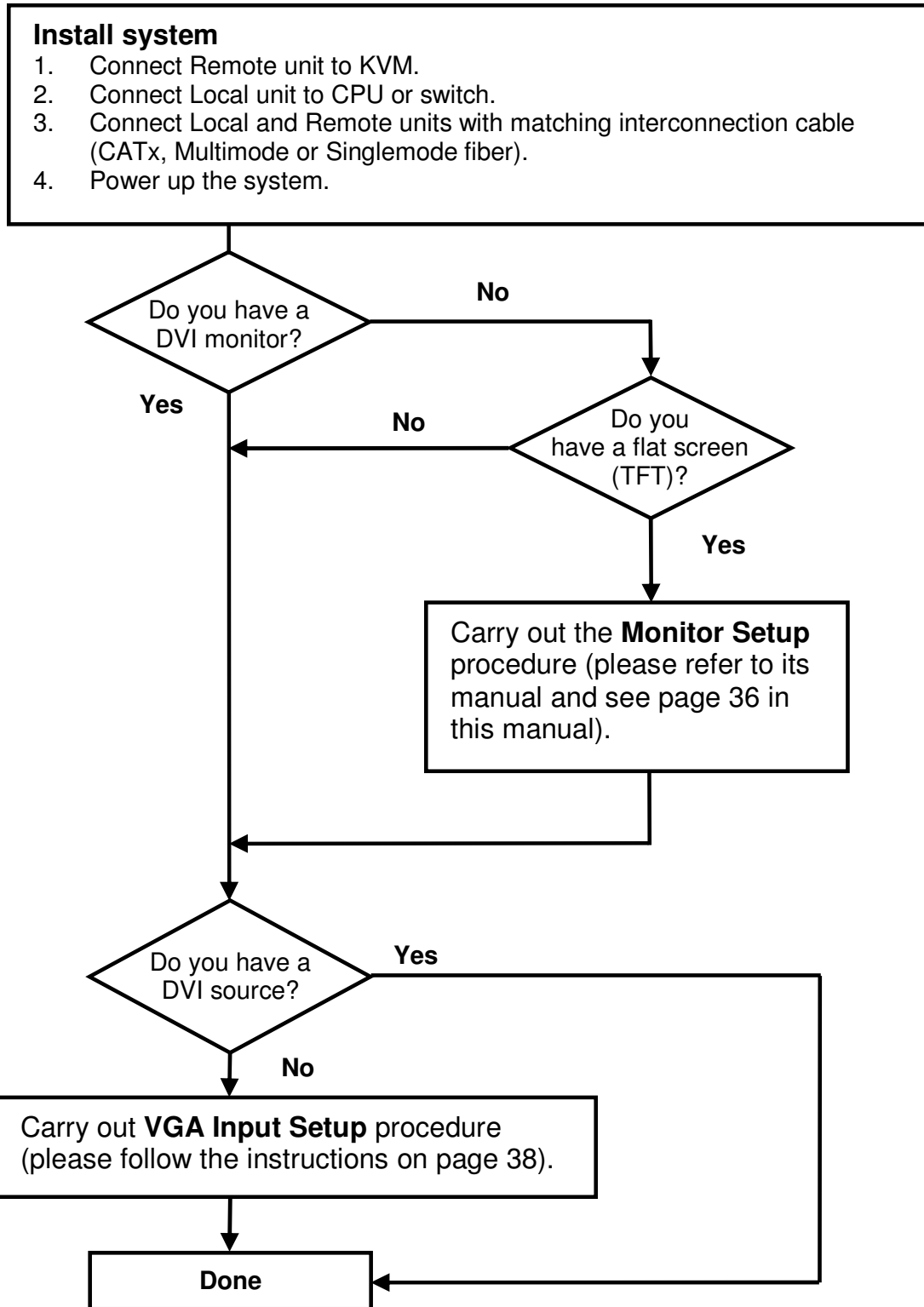

1.1 Video Input/Output



If possible, always use DVI output from your computer's video card and DVI input to a monitor. This provides the optimum video signal. If you use a VGA output from your graphic source, the DVI-KVM Local unit must digitize the signal prior to transmission. Similarly, if your remote TFT screen uses a VGA input, it must digitize the signal from the Remote unit. In both cases, the built-in video processors must determine the resolution and pixel phase for an optimized digitization. Your DVI Extender allows you to optimize the video signal manually or automatically using its on-screen utility (see **Chapter 4**). If you are using a VGA input to a TFT monitor, please follow the manufacturer's instructions.

You may have several possible options for video source output/monitor input. If this is the case, for the optimum video quality, please select the highest ranked available combination from the following table:

<i>Video Quality</i>	<i>Local Unit input</i>	<i>Remote Unit output</i>
1	DVI	DVI
2	DVI	VGA
3	VGA	DVI
4	VGA	VGA

1.2 Command Summary

The following table summarizes the 'hot' key command sequences used in system configuration and video tuning on a Remote unit console.

<i>Command</i>	<i>Keyboard at Remote unit</i>	<i>Terminal or Windows Utility program*</i>
Enter OSD	<Left Control> + <Left Shift> + <l>	<O> + <S> + <D> + <Enter>
Exit OSD	<ESC>	<X>
Select next position	<Right Arrow>	<R>
Select previous position	<Left Arrow>	<L>
Select Submenu	<Enter>	<S>
Select parameter modification	<Enter>	<S>
Increase parameter	<Right Arrow>	<R>
Decrease parameter	<Left Arrow>	<L>
Accept and store modified parameter	<Enter>	<S>
Back to the Menu selection		

* Commands are not case-sensitive.

2. Overview

2.1 Introduction

A basic KVM extension system comprises a *Local* unit (transmitter) and a *Remote* unit (receiver). The Local unit connects directly to the computer (or a KVM switch system) using the supplied cable(s). The user *console* (keyboard, mouse and monitor) attaches to the Remote unit. The Remote and Local units communicate video and data information along the interconnecting cable (see Figure 1). Local units offer dual access, allowing the connection of a second user console close to the computer. With the optional upgrade kit, you can also use DDXI DVI/VGA KVM Extender units to communicate stereo audio and serial port signals.

DDXI DVI/VGA KVM Extender Series enables high-resolution video, PS/2 keyboard and mouse signals to be communicated up to:

- 300ft (100m) over Category 5, 5e, 6 or higher (CATx) cable.
- 1200ft (400m) over Multimode fiber cable (50/125 μ).
- 600ft (200m) over Multimode fiber cable (62.5/125 μ).
- 6¼ miles (10km) over Singlemode fiber cable (9/125 μ).

In a digital application (DVI input and output), there is no loss of picture quality irrespective of extension distance and no adjustments are required. The DDXI DVI/VGA KVM Extender Series also supports traditional analog VGA as well as digital DVI. All combinations of DVI and VGA (graphics cards and monitors) are supported, allowing equipment to be mixed. In a mixed analog/digital application, some adjustment of the video signal is necessary to optimize the analog-digital signal conversions. DDXI DVI/VGA KVM Extenders are equipped with various automatic and manual video correction tools in an on screen utility (see page 25).

2.2 Glossary

The following terms are used in this guide:

CATx	Any Category 5, 5e, 6 or higher cable.
Multimode	Any multimode 2-fiber cable 50/125 μ or 62.5/125 μ
Singlemode	Any singlemode 2-fiber cable 9/125 μ
PSU	The desktop power supply connected to the Local/Remote unit.
KVM	Keyboard, Video and Mouse.
Console	A keyboard, monitor, and mouse, plus optional serial/audio devices.
Dual Access	A system allowing connection of Local and Remote user consoles.
Single Head	An extender system that supports one monitor.
Dual Head	An extender system that supports two monitors.

DDXI DVI/VGA KVM EXTENDER FAMILY

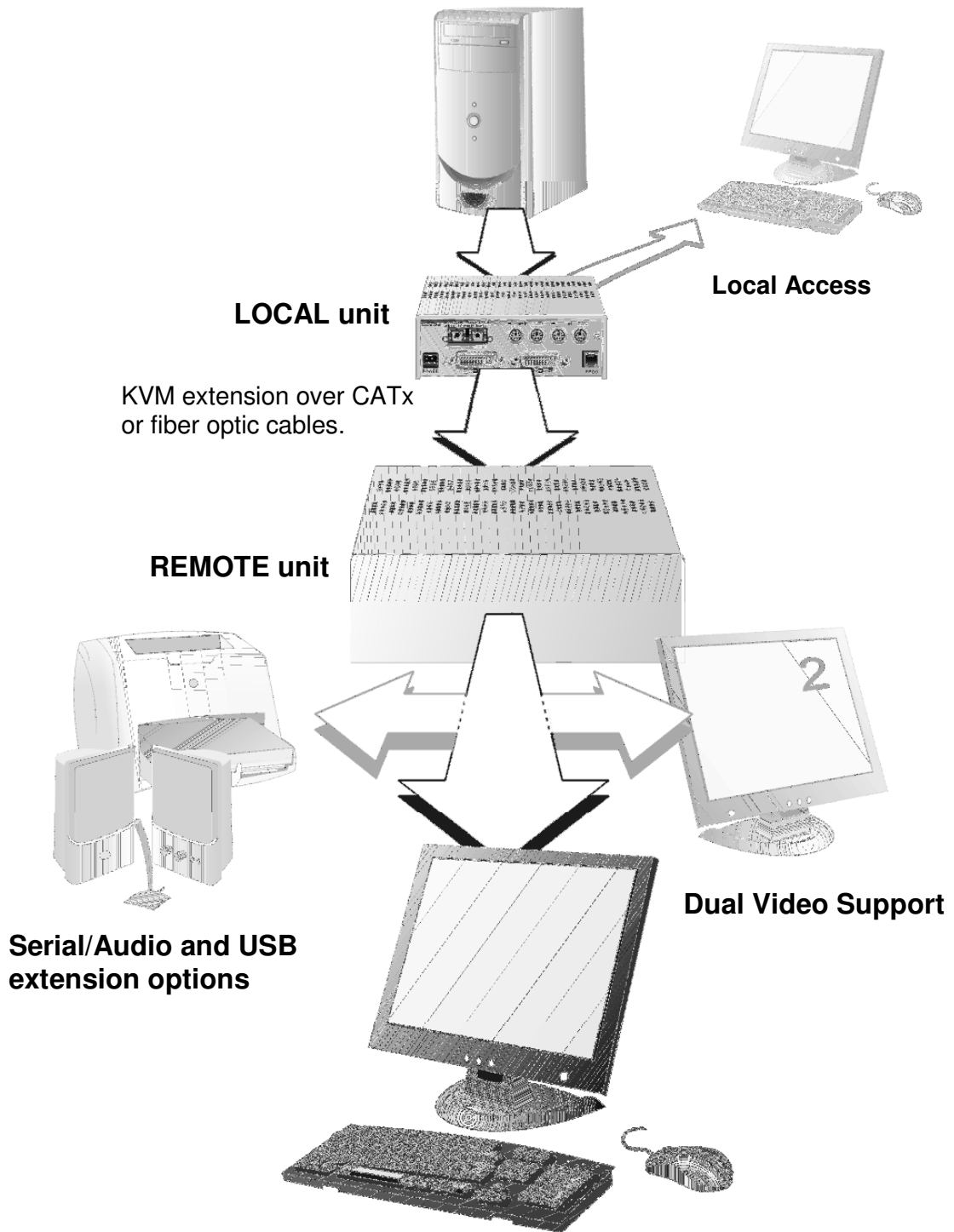

Figure 1 KVM extender system

2.3 Features

All members of the DDXI DVI/VGA KVM Extender Series offer the following features:

- Support for high video resolution over extended distances: 1600x1200@60Hz over all allowed distances - all lower resolutions with refresh rates of at least 75Hz
- An optional available device with higher data transfer (2,5GBit/sec) allows a resolution up to 1920x1200@60Hz
- All models come with dual access, to allow local or remote operation (Local DVI access limited to screen resolutions up to 1280x1024).
- All control and video tuning carried out using an on screen display (OSD) with settings stored in EEPROM memory.
- Local/Remote unit firmware and settings flash upgradeable.
- Intelligent PS/2 keyboard and mouse emulation ensures PCs do not lock-up and allows peripherals to be hot-plugged.
- Transparent serial port (on certain models) enables any serial device to be extended (up to 19.2K Baud). The serial port may be used to extend one device (requiring handshaking lines), or up to three simple serial devices (no handshaking).
- Bi-directional stereo audio (16-bit digitized) support on certain models enables high-quality, low-noise audio extension.
- USB support on certain models; connect up to four USB devices directly to the USB hub on the remote unit.
- Status indicator LEDs on each device.
- Small footprint chassis.
- Rack mount options available.
- CPU cables + Adapters included.

2.4 Product Range

There are eight products in the range and various upgrade kits:

<i>DVI/VGA-only devices</i>	
K439-0W	DVI Upgrade kit for additional video channel – CATx (also as option for Dual Head)
K437-0W	DVI Upgrade kit for additional video channel – Multimode (also as option for Dual Head)
K438-0W	DVI Upgrade kit for additional video channel – Singlemode (also as option for Dual Head)
<i>PS/2 Style Kits</i>	
K439-1W	DVI-Extender Set: PS/2 Dual Access, CATx
K437-1W	DVI-Extender Set: PS/2 Dual Access, Multimode
K438-1W	DVI-Extender Set: PS/2 Dual Access, Singlemode
<i>USB Style Kits</i>	
K442-2U	DVI-Extender Set: USB Dual Access, Multimode
K442-2U	DVI-Extender Set: USB Dual Access, Singlemode
<i>Upgrade Kits</i>	
421-AU	Audio/Serial Upgrade kit
421-TM	PS/2-keyboard/mouse Upgrade kit for USB devices
437-25	2.5Gbit Upgrade for Multimode devices with a resolution of 1920x1200 @60Hz
438-25	2.5Gbit Upgrade for Singlemode devices with a resolution of 1920x1200 @60Hz
437 -G2	Double-width housing (for Dual Head or audio/serial upgrades)

2.5 Compatibility

Interface Compatibility

- **PS/2 Keyboard:** Compatible with all standard keyboards. Certain keyboards with enhanced features may also be supported with custom firmware.
- **PS/2 Mouse:** Compatible with all standard 2-button, 3-button and wheel mice.
- **Audio:** Input and output are line-level. Amplified speakers are required. A microphone may be directly connected to the Remote unit (optional pre-amplification).
- **Serial:** Transparent up to 19.2K Baud. The following serial signals are extended: TX, RX, RTS, CTS, DTR, DSR. In rare cases, a wiring adaptor may be required to transfer RI and DCD.
- **USB:** compatible to USB 1.0 and USB 1.1. Transmission fully transparent. Some USB-CDROM or DVD burning devices may not work properly.
- **Analog Video:** VGA to UXGA. Separate sync, composite sync, or sync-on-green. Maximum resolution and refresh rates depend on cable length and cable type (see **Appendix H: Specifications**, page 42).
- **Digital Video:** DVI single link for resolution up to 1600x1200 at 60Hz. Frame rates and colors depend on device type (CATx or Fiber – see **Appendix D: Video Modes and Frame Rates**, page 49)

2.6 How to Use This Guide

This guide describes the installation and configuration of the DDXI DVI/VGA KVM Extender Series. Although the connection and operation of the system is relatively straightforward, you should consider the following before getting started:

Connection & Compatibility

If you have purchased an *Extender Kit*, this will contain all the cables required to connect the Local unit to your PC or KVM switch. The Remote console (keyboard, monitor and mouse) and any audio and serial equipment connect directly to the Remote unit.

For information about connection and installation, see **Installation**, page 17.

Interconnection Cable

For DVI-KVM -CAT Extenders, you will need CATx (any category 5, 5e, 6 or higher) cable, terminated with RJ45 plugs, to connect the Local and Remote units. Other units require singlemode or multimode fibers (see **Interconnection Cable Requirements**, page 18).

Adjusting Video

Due to the digital nature of the transmitted signals, there is no distortion of video signals or skew problem even with CATx interconnection cables.

If you do not have a DVI source and a DVI monitor, you will need to adjust the monitor and/or the Extender to the picture width and the pixel phase. You can do this using the Auto Adjust or Manual Adjust procedures (see page 37).

- For experienced users there is a **Quick Setup** section at the start of this guide (see page 8).
- For the full procedure, see **Monitor Setup** (page 36) and/or **Extender Setup** (page 37).

3. Installation

For first-time users, we recommend that you carry out a test placement, confined to a single room, before commencing full installation. This will allow you to identify and solve any cabling problems, and experiment with the DDXI DVI/VGA KVM-Extender more conveniently.

3.1 Package Contents

You should receive the following items in your extender package (all types):

- Extender Remote unit.
- 6V DC 12W universal power supply for Remote unit.
- Extender Local unit.
- 6V DC 12W universal power supply for Local unit.
- 2x DVI-I to VGA adapter (DVI-I dual link male to HD15 female) connector.
- 1x VGA to DVI-I adapter (HD15 male to DVI-I dual link female) connector.
- Programming cable (DB9 female to RJ11 4p4c).
- User manual.
- 2x German-type power cord.

All DVI/VGA-only models are supplied with:

- DVI-I video (DVI-I dual link male-to-male) connector

All PS/2 models are supplied with:

- KVM CPU cable set (1.8m) with PS/2 (6-pin mini-DIN male-to-male) keyboard and mouse connector and DVI-I video (DVI-I dual link male-to-male) connector

All USB types are supplied with:

- DVI-I video cable (DVI-I dual link male-to-male)
- USB cable (USB type A to type B)
- 5V DC 12W universal power supply for Remote unit (only required when connecting two or more High Power USB devices - see **Appendix E: USB – High Power/Low Power**).
- 1x German-type power cord (additional)

If anything is missing, please contact Technical Support (see **Appendix G: Calling Technical Support**).

3.2 Interconnection Cable Requirements

To connect the Local and Remote units you will need:

- **CATx Modules:** S/UTP (CAT5) cable acc. to EIA/TIA 56A or TSB 36 or Digital STP 17-03170. Four pairs AWG 24. Pinout acc. EIA/TIA 568A (10BaseT). Screen must be connected on both ends. Please ensure that the connection is tension-free.
- **Fibre Cables:**
 - **Multimode:** Two fibres 50µm or 62.5µm. E.g. I-V(ZN)H 2G50 (In house patch cable) or I-V(ZN)HH 2G62,5 (In house Breakout cable) or I/AD(ZN)H 4G50 (in house OR outdoor Breakout cable, stress resistant) or A/DQ(ZN)B2Y 4G62,5 (outdoor cable, stress resistant with protection against animal biting) All notations acc. VDE specification.
 - **Singlemode:** Two fibres 9µm. E.g. I-V (ZN)H 2E9 (In house patch cable) or I-V(ZN)HH 2E9 (In house Breakout cable) or I/AD(ZN)H 4E9 (in house OR outdoor Breakout cable, stress resistant) or A/DQ(ZN)B2Y 4G9 (outdoor cable, stress resistant with protection against animal biting) All notations acc. VDE specification.



A point to point connection is required. Having one or more patch panels in the line is possible and allowed. Not allowed is a connection from the fibre link interface to any other products, especially telecommunications or network equipment.

- **DVI, PS/2-Keyboard, PS/2-Mouse:** Connect the supplied KVM CPU cable set to your CPU (KVM.- Switch, etc.). Please ensure that the connection is tension-free! Devices K455-1W + K455-2W
- **DVI, USB-Keyboard, USB-Mouse:** Connect the supplied KVM CPU cable set to your CPU (KVM.- Switch, etc.). Please ensure that the connection is tension-free! Devices K455-1U + K455-2U
- **DVI:** Connect the supplied DVI CPU cable set to your CPU (KVM - Switch, etc.). Please ensure that the connection is tension-free! Devices K455-2W + K455-2U
- **VGA Input:** If you are using a VGA graphic source please use the delivered DVI/VGA adapter.
- **VGA Output:** If you are using a VGA monitor please use the delivered VGA/DVI adapter.
- **Power Supply:** Connect the supplied 6V/DC power supplies to the **Plug** terminal on the rear of both Local and Remote units.

USB devices have an additional power supply. You need to attach this PSU to the Remote unit if the total power consumption of the attached USB devices exceeds 500mA (see **Appendix E: USB – High Power/Low Power**).

3.3 System Setup

To install your DDXI DVI/VGA KVM Extender system:

1. Switch off all devices.
2. Connect your keyboard, monitor(s) and mouse to the Remote unit as shown in Figure 2 (K439-1W), Figure 4 (K437-1W/K438-1W) or Figure 6 (K442-2U/K443-2U).

 *These ports may also be attached to the CPU side of a KVM switch in order to have a Remote CPU. However, if you are attempting to use the extender between cascaded KVM switches this may not work. Please contact Technical Support to discuss your application.*

3. Connect the interconnect cable to the INTERCONNECT socket(s) as shown in Figure 2 (K439-1W), Figure 4 (K437-1W/K438-1W) or Figure 6 (K442-2U/K443-2U).
4. Connect the 6V power supply to power the unit.



Only use the power supply originally supplied with this equipment or a manufacturer-approved replacement.

5. Using the supplied CPU KVM cable(s), connect the keyboard, monitor(s) and mouse connectors on the computer (or KVM switch) to the corresponding connectors on the Local unit as shown in Figure 3 (K439-1W), Figure 5 (K437-1W/K438-1W) or Figure 7 (K442-2U/K443-2U).

Ensure that you attach the keyboard and mouse connectors to the correct ports. The keyboard connector is purple; the mouse connector is green.

 *If your PC does not have a PS/2 mouse port, an active serial converter will be required*

6. For a dual access system, connect the keyboard, mouse and monitor for the Local console to the appropriate ports on the Local unit. The ports may also be used to feed into a KVM switch.
7. Connect the Interconnection cable from the Remote unit to the INTERCONNECT socket on the Local unit as shown in Figure 3 (K439-1W), Figure 5 (K437-1W/K438-1W) or Figure 7 (K442-2U/K443-2U).
8. Power up the system.

DDXI DVI/VGA KVM EXTENDER FAMILY

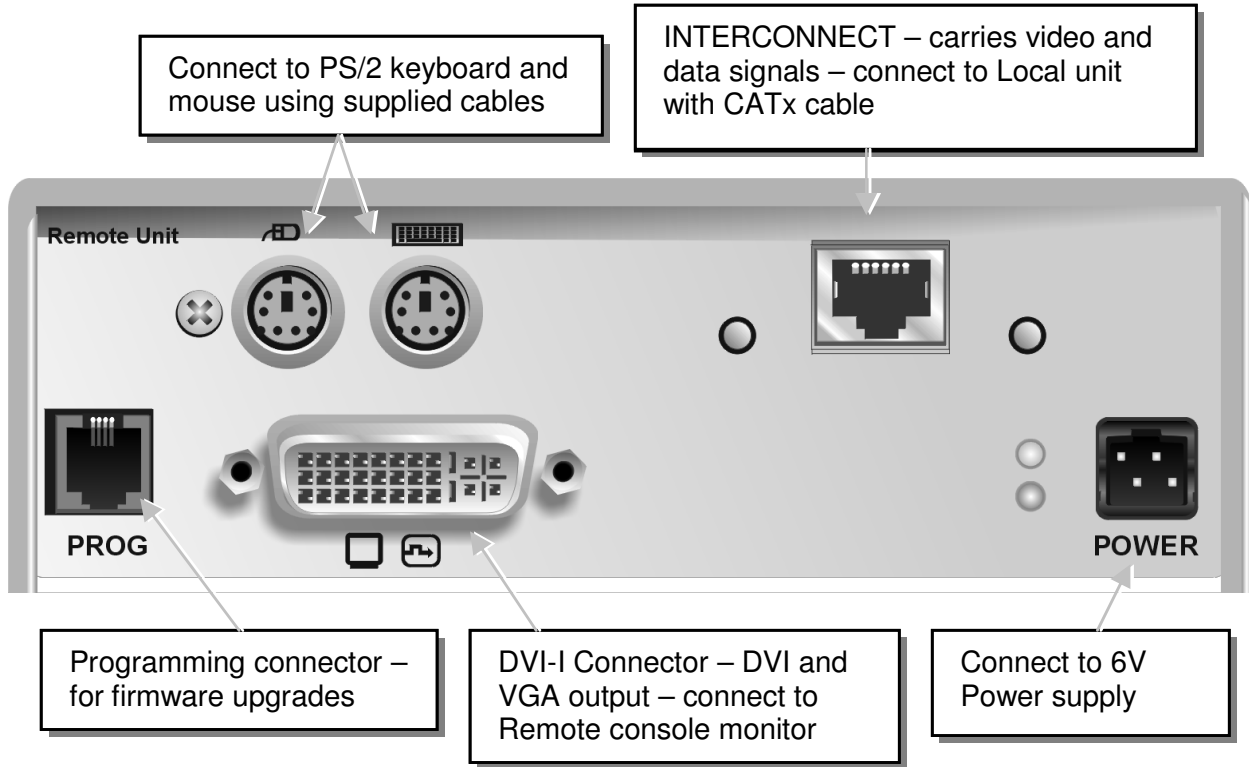

Figure 2 K439-1W Remote Unit

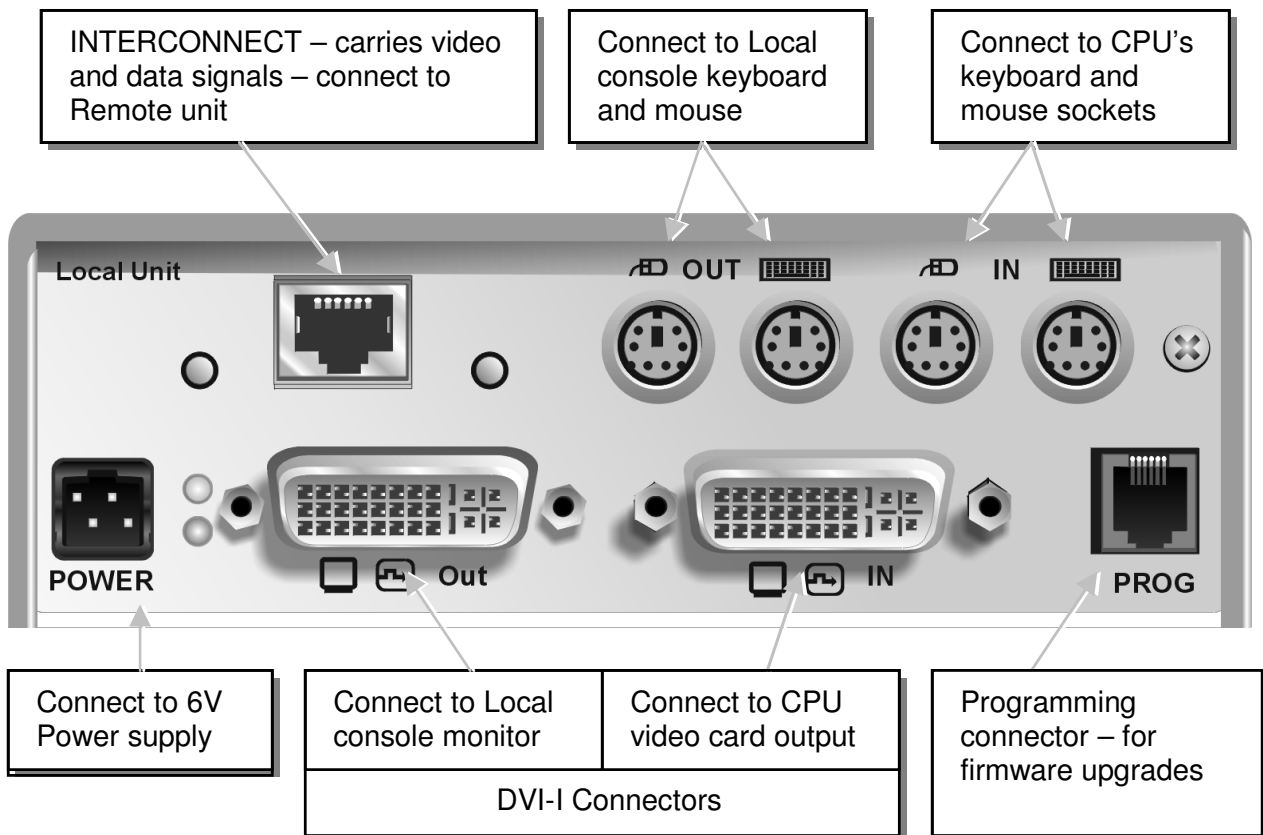

Figure 3 K439-1W Local Unit

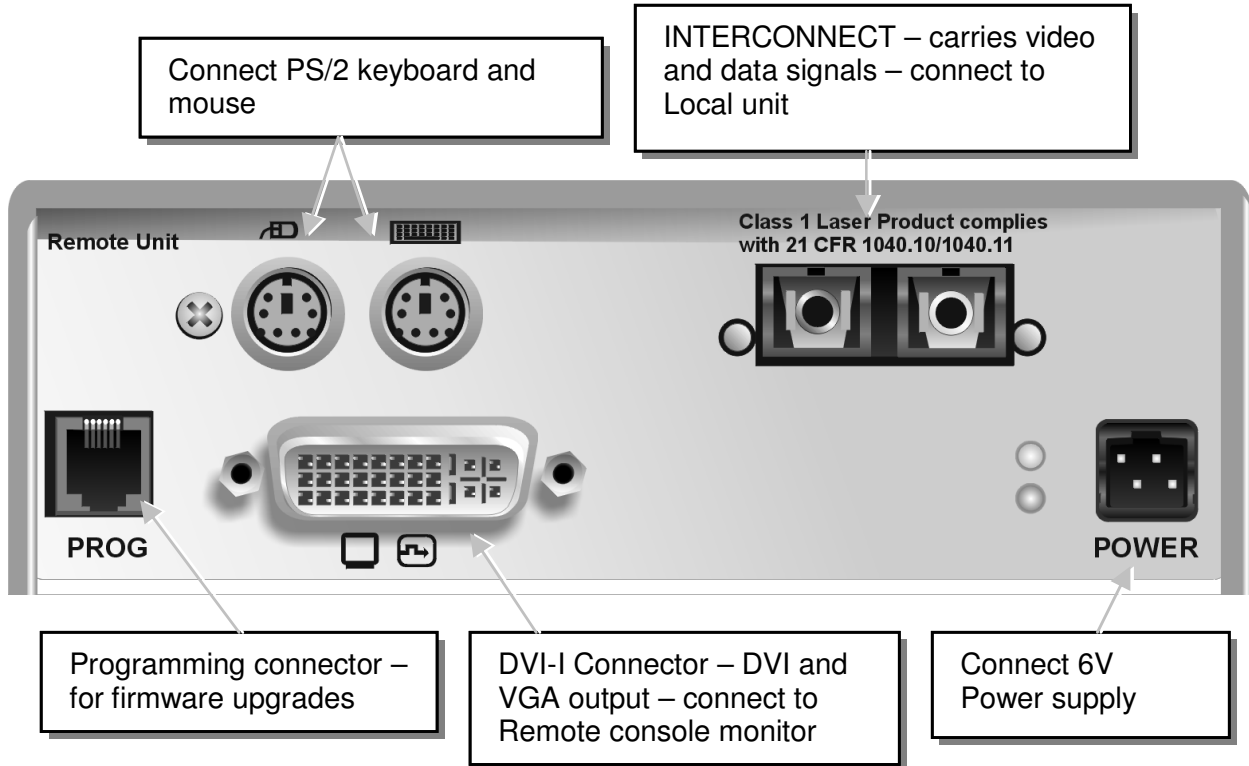

Figure 4 K437-1W/K438-1W Remote Unit

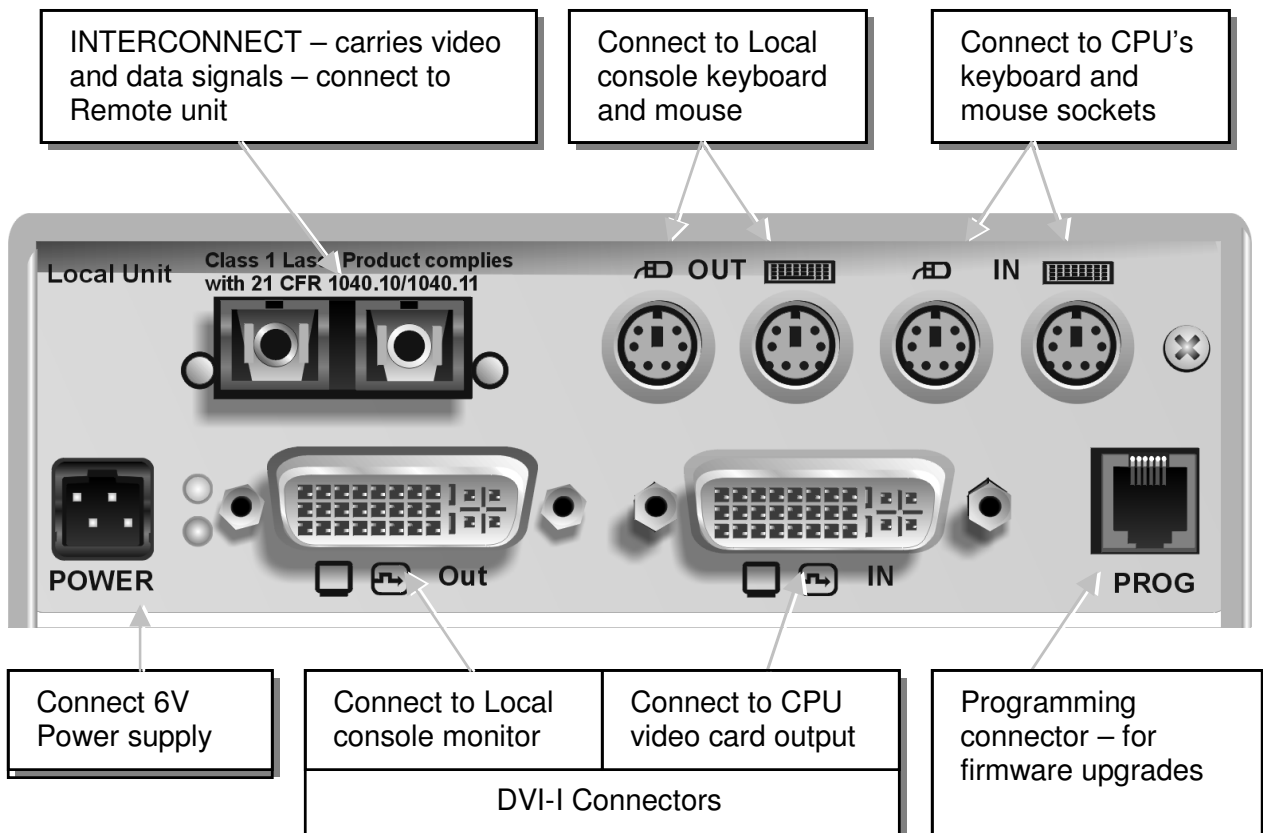

Figure 5 K437-1W/K438-1W Local Unit

DDXI DVI/VGA KVM EXTENDER FAMILY

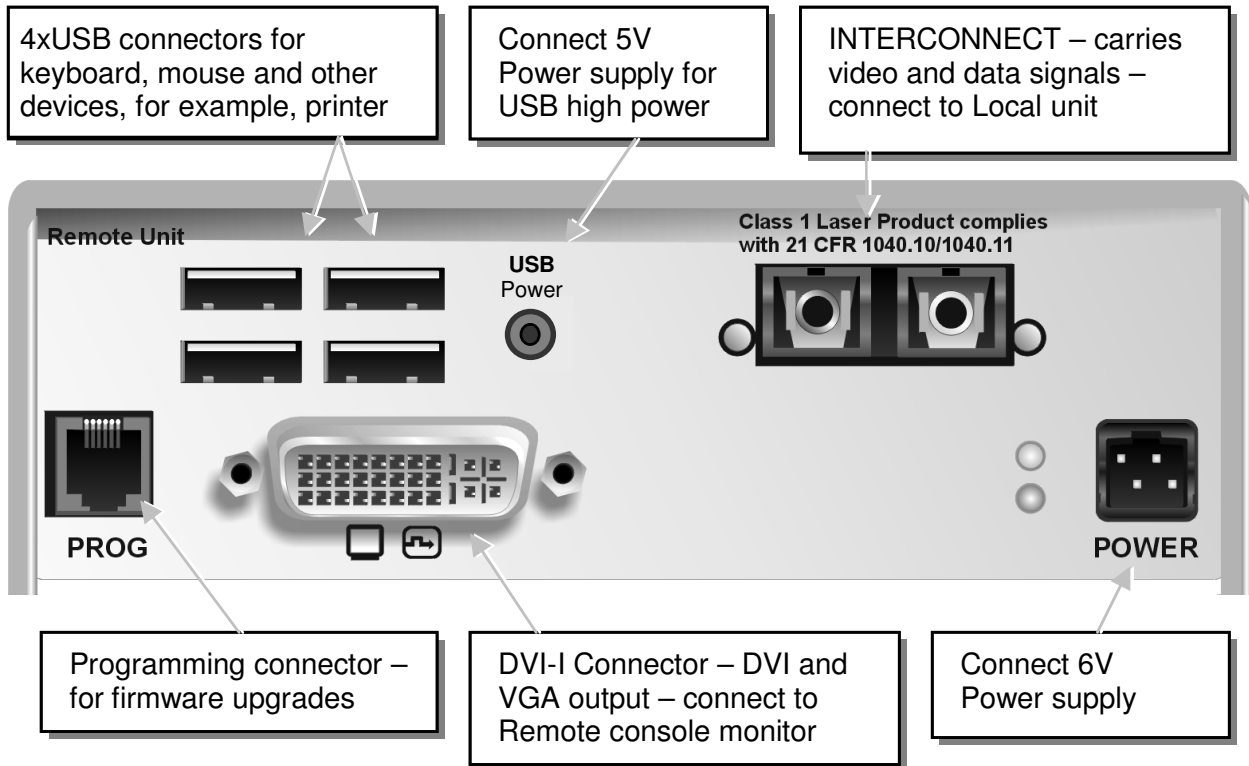

Figure 6 K442-2U/K443-2U Remote Unit

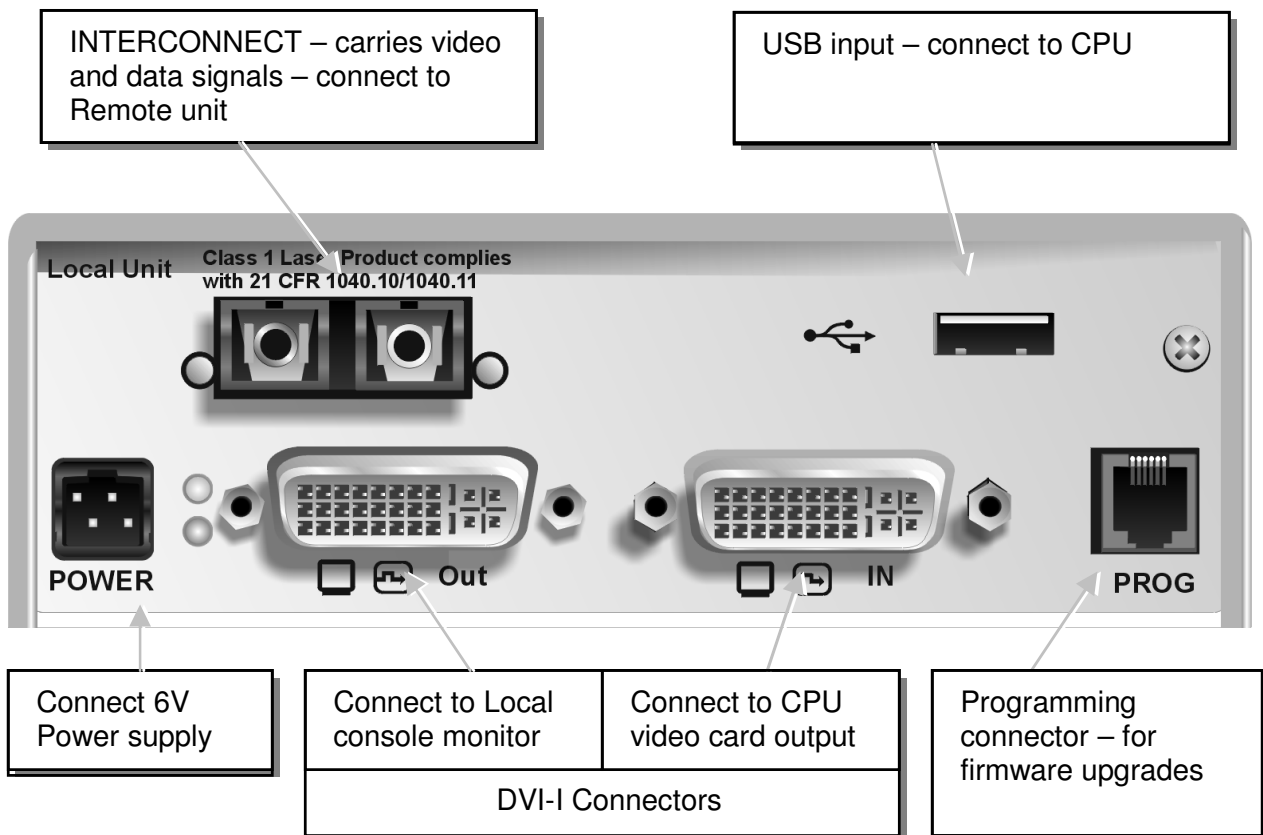

Figure 7 K442-2U/K443-2U Local Unit

3.4 Diagnostic LEDs

Each Extender unit is fitted with four indicator LEDs: *Communication Error*, *Link Status*, *Device Ready* and *Video Signal*. The Indicator LEDs are located in the same positions on all models in the DDXI DVI/VGA KVM Extender range. The *Communication Error* and *Link Status* LEDs are to the left and right, respectively, of the Interconnect sockets. The *Device Ready* and *Video Signal* LEDs are next to the Power socket.

As an example, the location of the LEDs is shown below for K439-1W Remote and Local units:

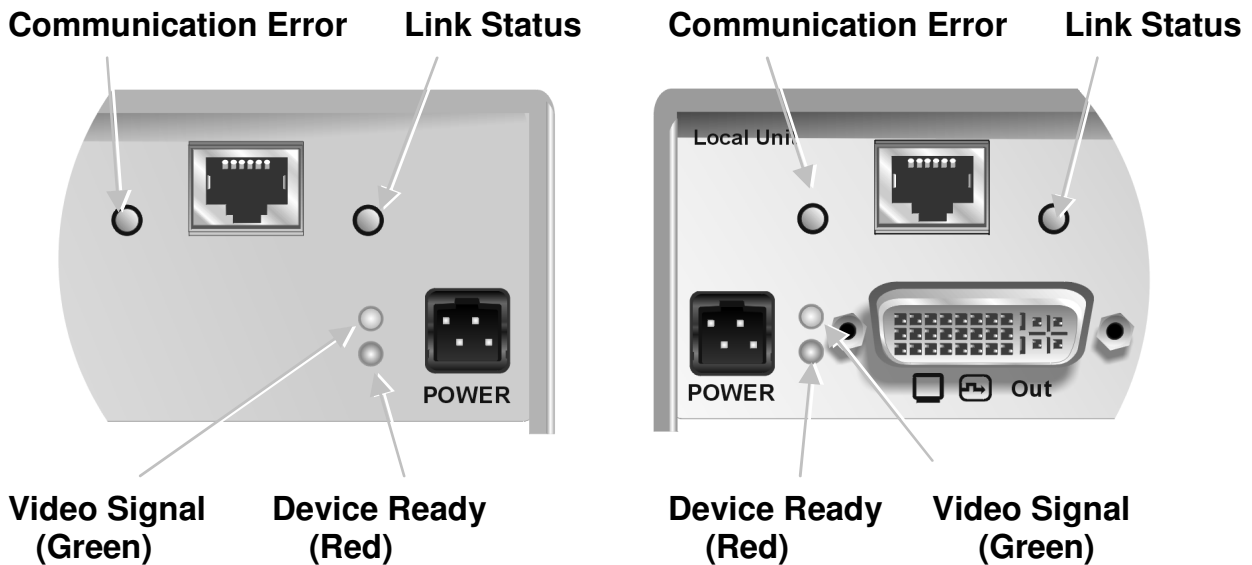

Figure 8 Diagnostic LEDs on Remote (left) and Local (right) K439-1W units

LED	Appearance	Diagnostics
Communication Error	Off	No communication error for >60 minutes
	Flashing	Indicates number of communication errors during previous 60 minutes:
	slow	10-100 (CATx) 1-2 (Fiber)
	medium	100-1000(CATx) 3-10 (Fiber)
	fast	>1000 (CATx) >10 (Fiber)
Error counter cleared automatically 60 minutes after previous communication error.		
Link Status	On	Link connection is locked
	Flashing	Interconnection cable not connected or not functioning
Device Ready (Red LED)	Off	Device not ready
	On	Device ready
Video Signal (Green LED)	Off	No video signal or valid mode detected
	On	Attached and valid mode detected

3.5 Access Switching

PS/2 variants of the DDXI DVI/VGA KVM Extender series offer dual access through both Local and Remote consoles (see Figure 1). Keyboard and mouse activity operates on a first-come, first-served basis. When the keyboard and mouse is in use at one console, the Extender blocks access at the other until there is no keyboard or mouse activity for a defined period – the inactivity timeout (2 seconds – the default, or 15 seconds). A user can then gain control by any keyboard action or by pressing left and right mouse buttons simultaneously.

The inactivity timeout period and the choice of keyboard only or mouse and keyboard initiation is determined by jumper settings on the keyboard/mouse daughterboard (see **Appendix C: System Upgrade & Dual Access**, page 48).

3.6 Private Mode

On PS/2 systems, a user at one console can lock out the other console by triggering a 'Private Mode' function. This prevents the inactive console from being used, even if the inactivity timeout period expires.

To start a Private Mode session on a console, press the 'hot' key command sequence:

<Ctrl> + <Shift> + <Scroll Lock>

On the other console, to indicate that a Private Mode session has been started, the extender system:

- Illuminates the Num Lock, Caps Lock and Scroll Lock LEDs on the keyboard.
- Displays a blank image on the console's monitor.
- Locks the keyboard and mouse.

To end the Private Mode session, press the 'hot' key command sequence again.

4. Device Control

If you are using the DVI output from your video card and the DVI input to a TFT monitor, no adjustment should be required. In other cases, when the video signal is converted between analog and digital formats, either by the Local unit and/or the monitor, you may need to optimize the video signal using the Extender's on-screen display (OSD).

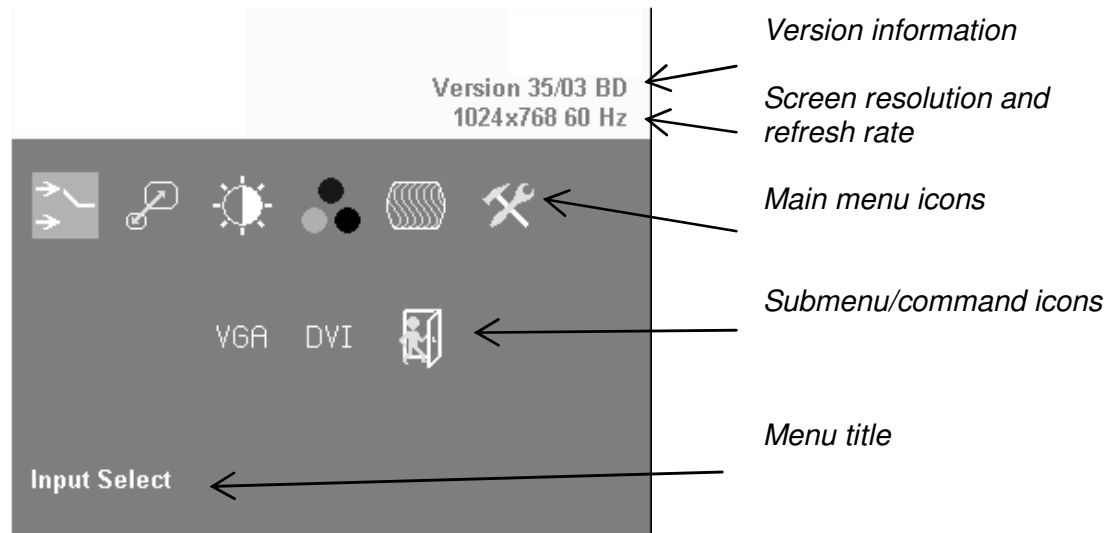

Figure 9 OSD Utility

You can adjust the following properties using the OSD:

- Adaptation to analog signal sources (VGA/RGB) – see also **Monitor Setup**, page 36.
- Color temperature
- Brightness/contrast
- Saturation
- OSD operation, factory reset.

4.1 Opening the OSD

You can access the OSD in two ways:

- Using the keyboard attached to the Remote Unit:
Note. On USB devices (K442-2U/K443-2U) or DVI upgrade kits (K347-0W/K438-0W/K439-0W), keyboard access is not available. Please use the other method:
- Using our small WINDOWS™ program with a serial connection to the programming port.

While the OSD is active, the mouse is locked and only menu keystrokes are allowed at the keyboard. To indicate that the OSD mode is active, the status LEDs (Num Lock, Caps Lock and Scroll Lock) are flashed. There is a summary of OSD commands on page 10.

Using the keyboard attached to the Remote Unit

Type the following key sequence at the Remote console keyboard:

<Ctrl> + <Shift> + < I >

Note. On some keyboards, <Ctrl> is replaced by <Strg>.

To navigate within the OSD:

- Use the left and right arrow keys to highlight a submenu and/or function.
- Press the <ENTER> key to select the highlighted submenu or function.
- Select the Exit icon to go back to the previous menu level.
- Press the <ESC> key to exit the OSD mode.

Using our WINDOWS™ program

On all devices, you can use our small WINDOWS™ program, running on a WINDOWS™ computer for OSD access:

1. Download the program from our server
2. Connect the programming cable to the programming port of the Remote unit.
3. Connect the programming cable to the serial port of your computer, where the program is running.
4. Start the program and follow the on-screen instructions.
5. Type in the following key sequence:
< O > + < S > + < D > followed by **<ENTER>**

When the OSD starts, it displays information about the attached device and firmware version, for example:

Modul Name : DVI-KVM-121o
Version : Vers.1.3
Date : 03/05/15

To navigate within the OSD:

- Use the <L> and <R> keys to highlight a submenu and/or function.
- Press the <S> key to select the highlighted submenu or function.
- Select the Exit button to go back to the previous menu level.
- Press the <X> key to exit the OSD mode.

4.2 Using the OSD

The OSD is an icon-based utility. The top line of symbols shows the main menu categories:



Input Select

Specify whether the input is analog (VGA) or digital (DVI)



Scale Mode

Choose whether transmission occurs at the original screen resolution (“transparent”) or the Extender imposes a fixed resolution.



Brightness – Contrast

Adjust brightness or contrast or reset to default values.



Color

Adjust color calibration, temperature, flesh/skin tone, hue and saturation.

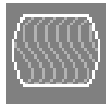

Image

VGA Input source only - Adjust pixel clock and phase.



Tools

Set OSD position and size, fixed scale sharpness, color depth, factory reset.

1. Use the left and right arrow keys (<L> and <R> keys on terminal or in Windows program) to highlight the icon you want. The OSD displays additional icons relating to commands in the selected menu category.
2. Press the Enter key (<S> key on terminal or in Windows program). The OSD highlights the first command icon.
3. Use the Left and Right arrow keys (<L> and <R> keys on terminal or in Windows program) to highlight the command or submenu you want. In the case of the latter, your selection will cause the OSD to display additional command icons (Color Temperature commands, for example).
4. Press the Enter key (<S> key on terminal or in Windows program) to accept a highlighted command. If this requires the increase or decrease of a value (Contrast, for example), the OSD displays a value bar:



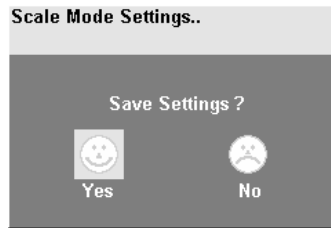

5. Use the Left and Right arrow keys (<L> and <R> keys on terminal or in Windows program) to change the value as required.

- In many cases, after you have chosen a new setting, the OSD displays the following confirmation message:



- Highlight the *Yes* button and press the Enter key (<S> key on terminal or in Windows program) to confirm your choice. Alternatively, highlight the *No* button and press the Enter key (<S> key on terminal or in Windows program) to discard the new setting and restore the previous value.
- Select the Exit icon to close a submenu.
- Press the Esc key (<S> key on terminal or in Windows program) to close the OSD, saving all settings, and restore normal mouse and keyboard functions.

The following table summarizes the keyboard actions and icons used to navigate the OSD utility, and to select and adjust the Extender's parameters:

<i>Key/Icon</i>		<i>Action</i>
<i>Remote Keyboard</i>	<i>Terminal or Windows program</i>	
Esc	<X>	Close the OSD, restore normal keyboard and mouse functions.
		Return to previous Menu selection.
Enter	<S>	Open the highlighted menu or submenu Accept the highlighted command
Left arrow	<L>	Select the previous menu or command icon Decrease the highlighted parameter
Right arrow	<R>	Select the next menu or command icon Increase the selected parameter

DDXI DVI/VGA KVM EXTENDER FAMILY

Input Select



Some graphic cards are equipped with both DVI and VGA outputs. On powering up the CPU, the Extender system uses the first detected signal unless you explicitly specify the input type. Use the Input Select menu to specify the type of video signal to be used by the Local unit. The actual graphic source is displayed with a '✓' symbol (for example, VGA✓).

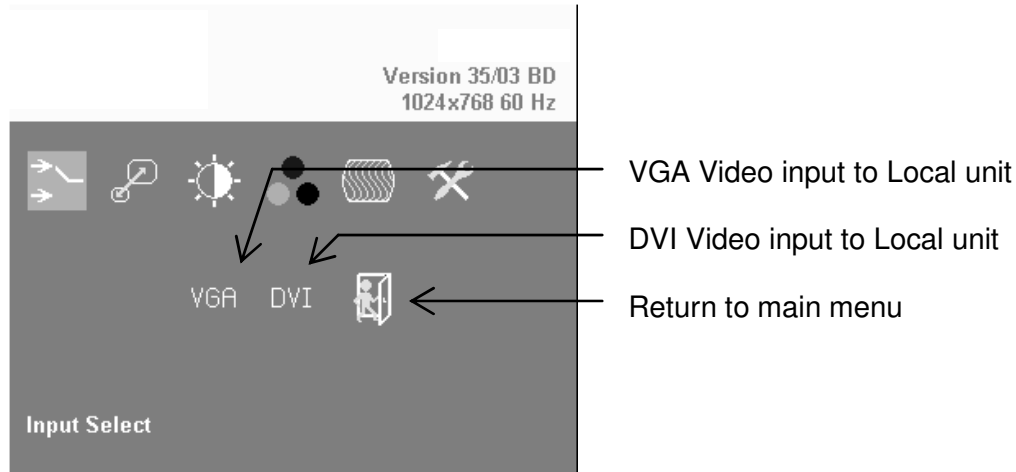

Figure 10 Input Select menu

Scale



Use the Scale menu to specify whether the Extender system changes the resolution of the input video. You can set the device for *transparent* transmission. In this case, the Remote unit generates a screen resolution and refresh rate to match that of the source. You can also specify that the output displays at a fixed screen resolution, regardless of that of the input signal. You might want to use a fixed resolution if your monitor is not able to display the generated resolution or, for example, if you have a server farm with many different CPUs each having a different screen resolution. With a transparent transmission, it could take a long time to regain a picture on the screen.

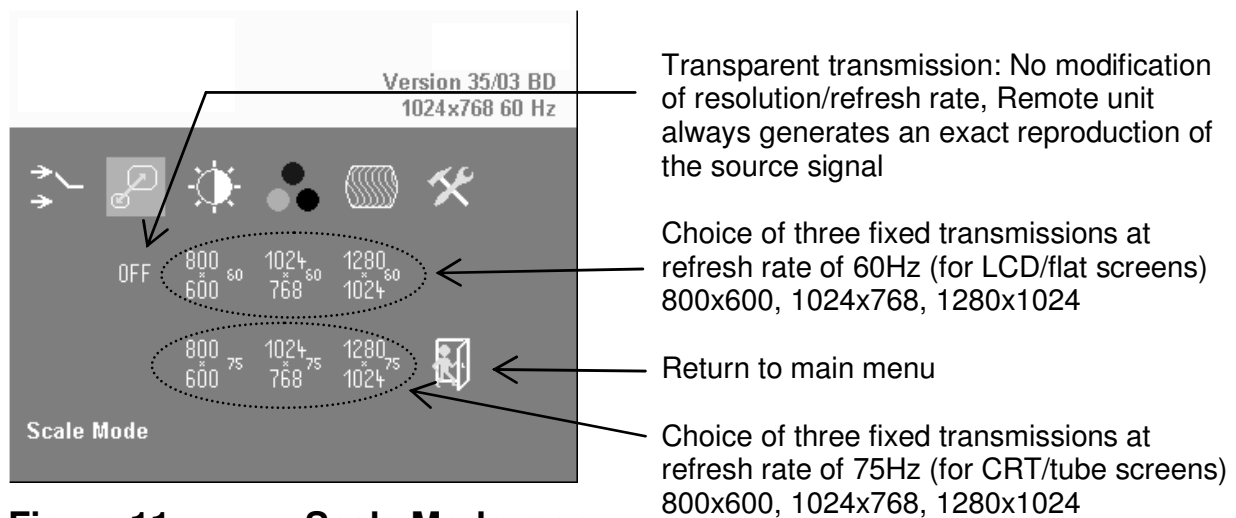

Figure 11 Scale Mode menu

Downscaling is only available with VGA signals. With a DVI input, you can select downscaling but it will not work – only upscaling has an effect.

Brightness/Contrast



Use this menu to adjust the brightness and contrast of the video image, or to adjust the black level of an LCD display.

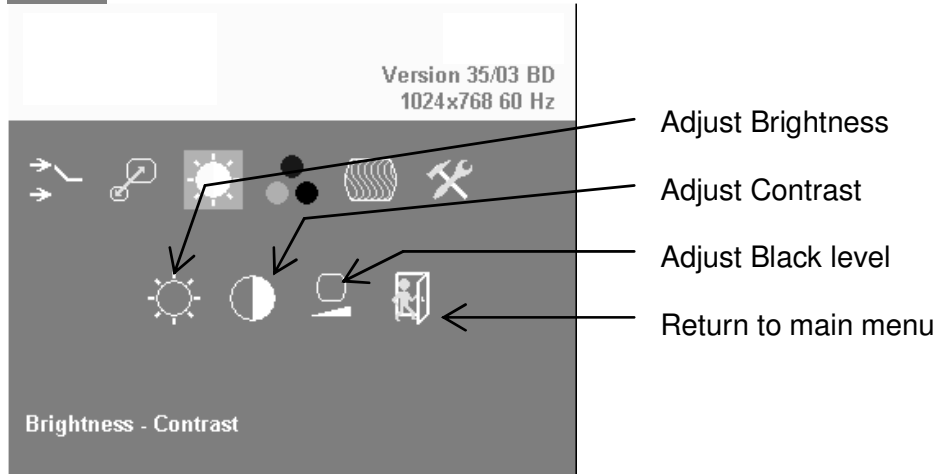

Figure 12 Brightness-Contrast menu

Select Colors and Color Temperatures



Use the Colors menu to adjust the color balance of the video image. The menu provides a number of options including automatic calibration, manual adjustment in RGB or CMY color space, hue and saturation adjustment and the setup of flesh/skin tone.

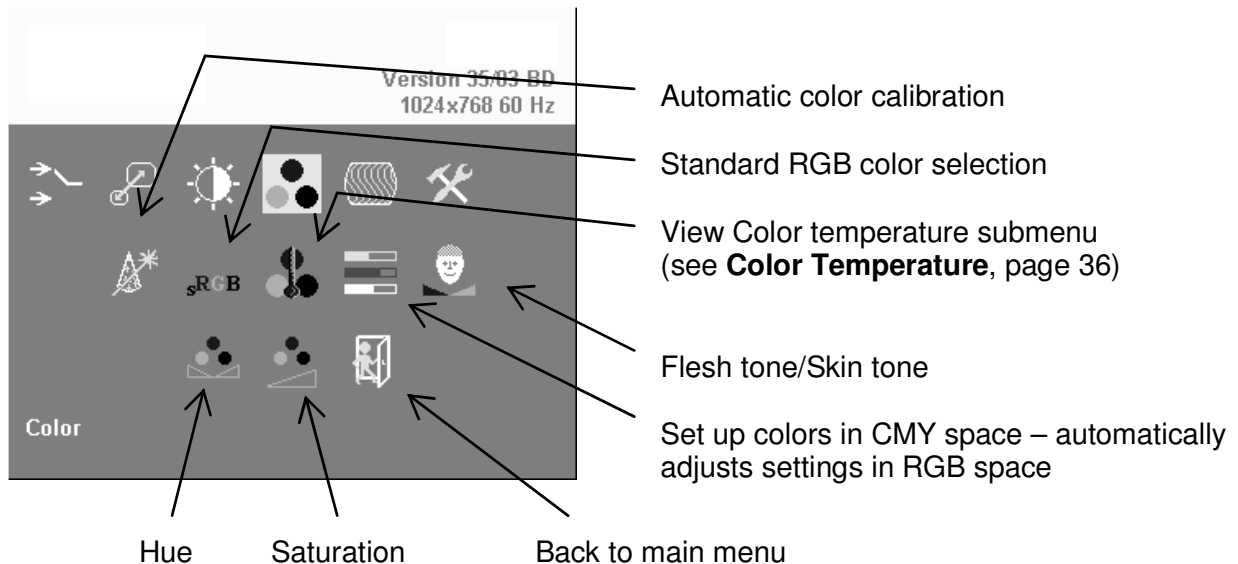

Figure 13 Color menu

Color Temperature



Use the Color Temperature submenu to set up the color profile in RGB color space or by using one of five predefined color temperatures. To view this menu, select the Colors icon from the main menu and then select the Color Temperature icon.

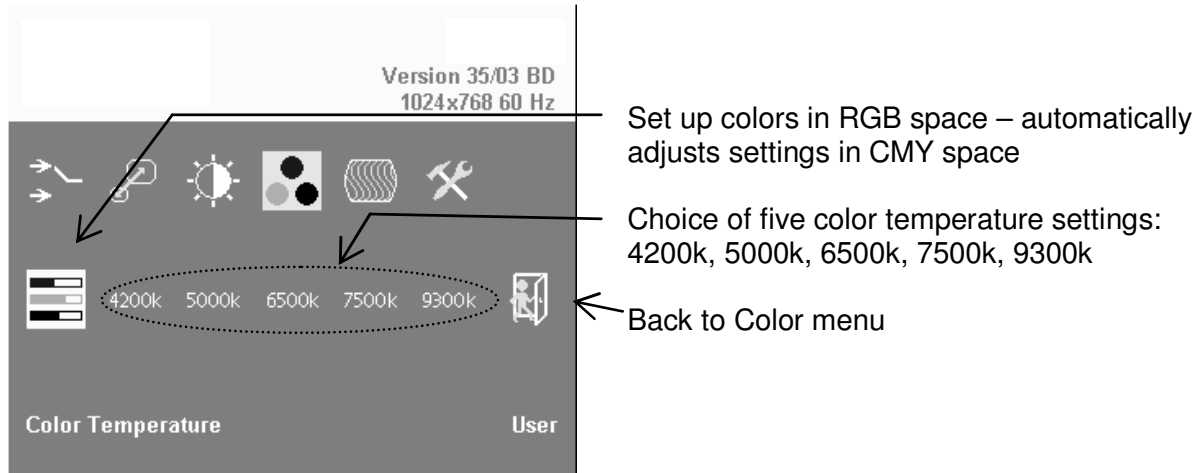
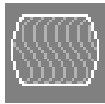

Figure 14 Color Temperature submenu

Image



VGA inputs only

Use the Image menu to adjust the vertical and horizontal screen position and to set the pixel clock and phase.

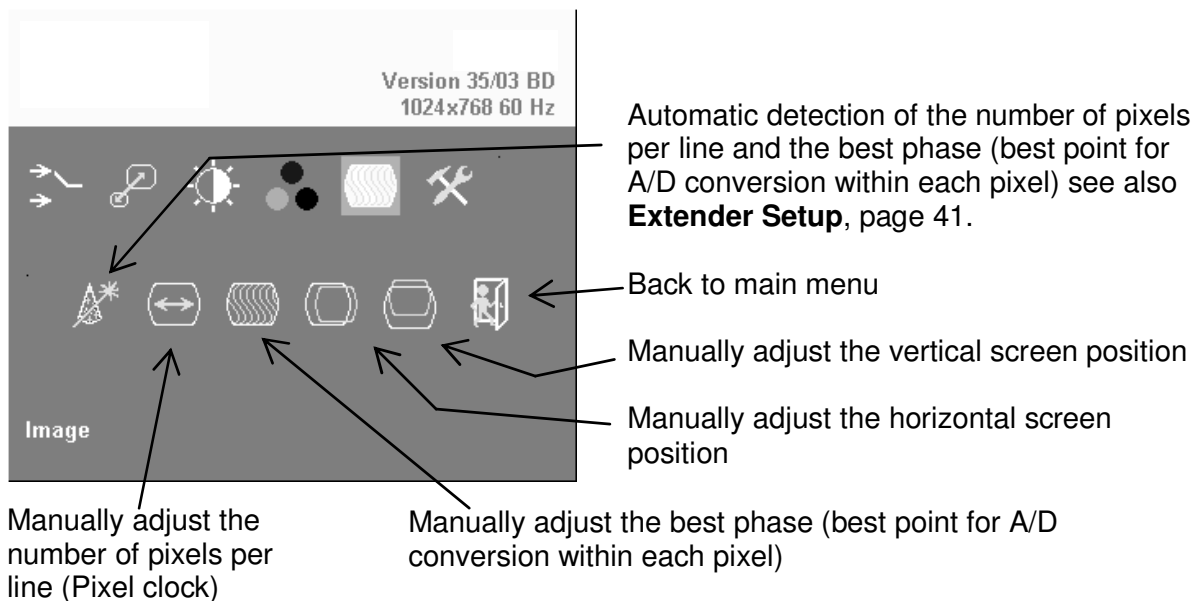
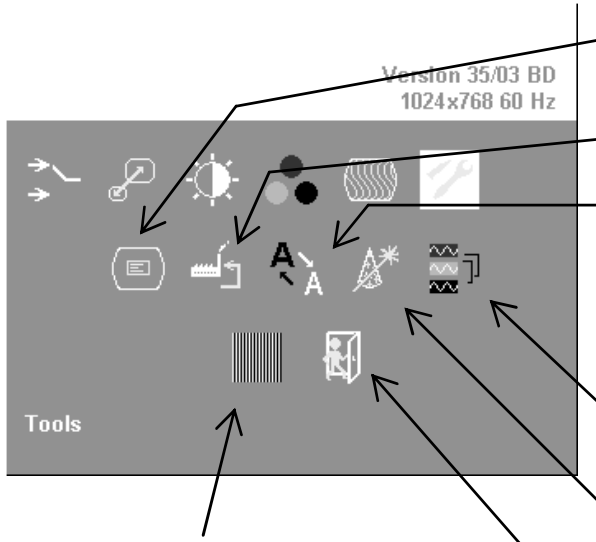

Figure 15 Image menu

Tools



Use the Tools menu to set the position and size of the OSD window, adjust the sharpness for a fixed resolution setting, set the color depth, reset the Extender system to its factory default settings or provide a test pattern.



Set the position of the OSD window (see **OSD**, page 37)

Reset Extender to factory default settings

Adjust sharpness (fixed resolution modes only). When resolution is changed by an imposed fixed resolution, sharpness can be affected. Use this option to switch between three settings for optimum sharpness

Select color depth (see **Color Depth**, page 39)

Choose whether to automatically adjust pixels per line and pixel phase after a mode change (see **Factory Reset**

Use the Factory Reset submenu to reset the unit to factory defaults, save user presets or restore user

Display a 'burst' pattern at the remote console for monitor setup (see **Monitor Setup**, page 42)

Figure 16 Tools menu

OSD



Use the OSD submenu to define the position and size of the OSD window. To view this menu, select the Tools icon from the main menu and then select the OSD icon.

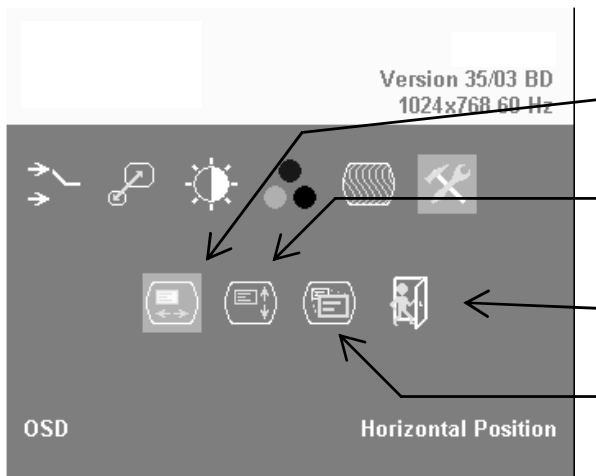

Manually adjust the horizontal position of the OSD window

Manually adjust the vertical position of the OSD window

Back to Tools menu

Toggle the size of the OSD window between single and double size

Figure 17 OSD submenu

Factory Reset

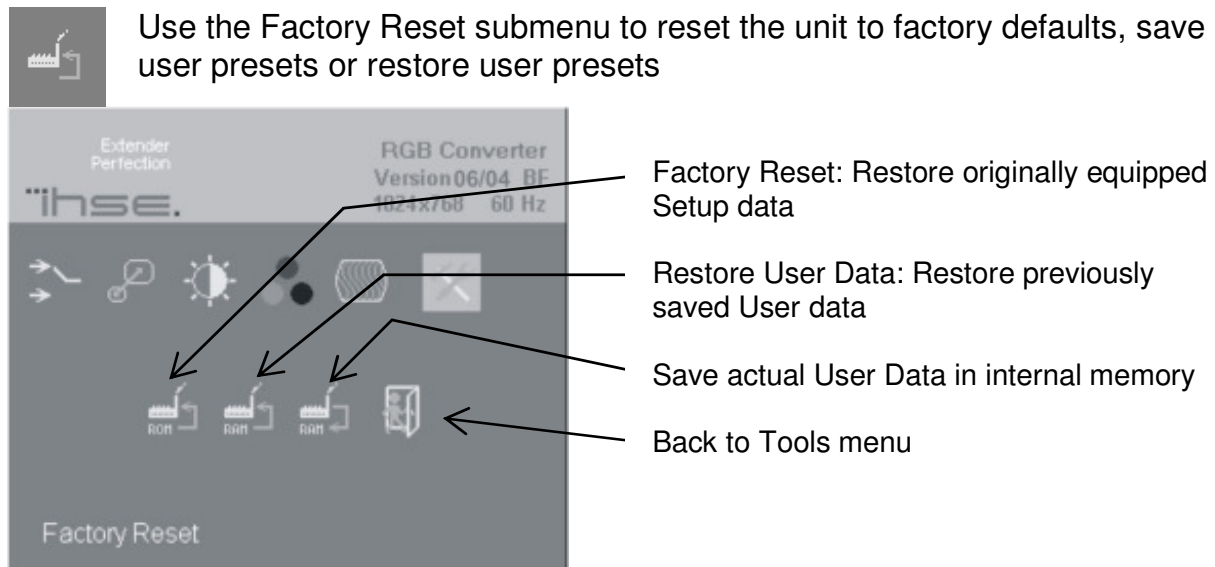

Figure 18 Factory Reset sub-menu

Auto Configuration

Use the Auto Configuration submenu to define whether the Local unit carries out automatic detection of the number of pixels per line and the best phase after a mode change (a change of screen resolution and/or refresh rate at the graphic source). Using automatic detection (while displaying an appropriate test pattern) ensures an optimized image but the procedure introduces a delay in the picture appearing on the remote console screen. If you want the picture to appear as fast as possible, and can tolerate a non-optimized image, you may want to disable this feature. Please note that Auto Configuration is disabled in the default factory settings.

To view the Auto Configuration menu, select the Tools icon from the main menu and then select the Auto Configuration icon.

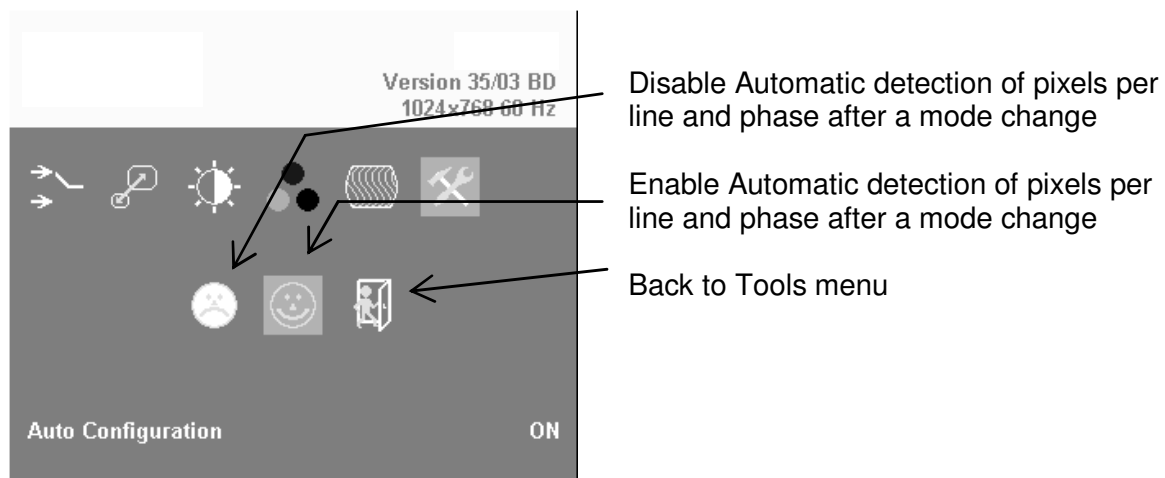

Figure 19 Auto-Configuration submenu

Color Depth



Use the Color Depth submenu to select the color depth of the transmitted screen picture. Transmissions can be in high color mode or low color mode. High color mode produces a better quality image but results in a lower frame rate (fps). Use low color mode if you require fast screen changes, for example video applications. Use high color mode if you need precise images, for example, medical applications. Please see **Appendix D: Video Modes and Frame Rates** (page 49) for more information about frame rates and supported screen resolutions.

<i>Color Depth</i>		
<i>Color Mode</i>	<i>CATx</i>	<i>Fiber</i>
Low	5 bits/color 15 bits total 32768 colors	6 bits/color 18 bits total 262144 colors
High	7 bits/color 21 bits total 2.1M colors	8 bits/color 24bits total 16.78M colors

To view this menu, select the Tools icon from the main menu and then select the Color Depth icon.

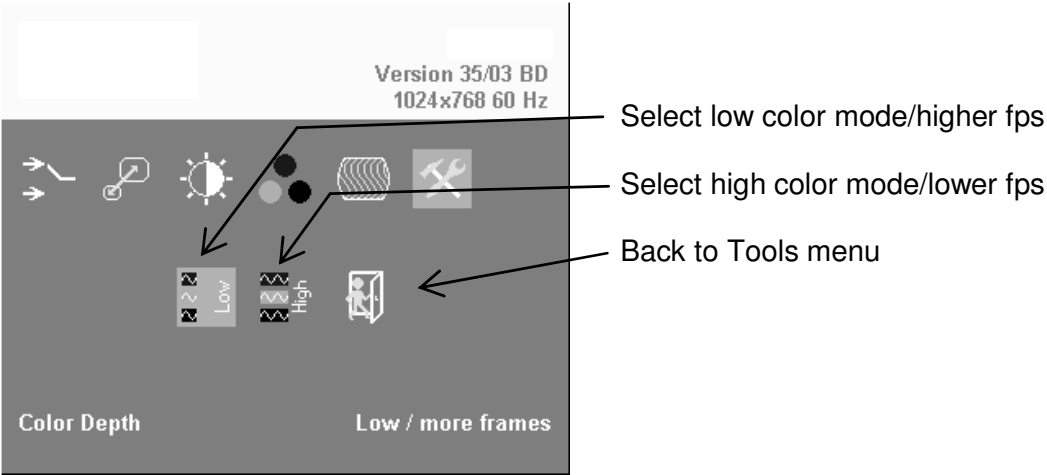

Figure 20 **Color Depth submenu**

5. Monitor Setup

This procedure is designed to correct for discrepancies in the video signal due to analog/digital video conversion by the Monitor. You do not need to follow this procedure if you have:

- A CRT monitor connected to the Remote unit through the VGA input
- A TFT monitor connected to the Remote unit through the DVI input

In these cases, there is no need to adjust the monitor because the video format is not converted.

Please make sure that you carry out this procedure before Extender Setup (page 37). If you are using a TFT monitor at the remote console with a VGA cable, both the Extender AND the TFT monitor digitize the video data stream and affect video quality. By setting up the TFT monitor first, you ensure that you are correcting discrepancies due solely to the Extender system in the Extender Setup procedure.

1. Connect the Extender system and display the regular desktop in the desired screen resolution. Monitor setup may vary depending on screen resolution and/or refresh rate.
2. Display the OSD utility (see page 26).
3. Select the Tools menu option (see page 33).
4. Select the 'burst' pattern option. Your TFT should show fine, 1 pixel wide, black and white vertical stripes over the entire screen. The OSD will stay visible in the middle of the screen.
5. Depending on the type of TFT, press the 'AUTO' Button on the monitor control panel or select *Auto Adjust* in the TFT Setup Menu. Refer to the manual supplied with your monitor for more information.
6. If the vertical stripes are sharp and without jitter or smearing, the adjustment has been successful. Go to step 8.
7. If the picture quality is not acceptable after the automatic adjustment, you will have to manually adjust the pixel clock and pixel phase (in this order). Please follow the instructions in your monitor's user manual.
8. Press any key to exit the test pattern display.
9. Exit the OSD.

6. Extender Setup

6.1 Overview

You need to optimize the video signal across your Extender system if it undergoes one or more conversions between analog and digital formats. The exact procedure depends on your Extender setup:

<i>Graphic s card</i>	<i>Monitor type</i>	<i>Monitor Input used</i>	<i>Video Optimization Procedure(s)</i>
VGA	TFT	VGA	TFT adjustment (see Monitor Setup , page 36) Optimization using OSD (see Setup Instructions for VGA Input , page 38)
VGA	CRT	VGA	Optimization using OSD (see Setup Instructions for VGA Input , page 38)
VGA	TFT	DVI	Optimization using OSD (see Setup Instructions for VGA Input , page 38)
DVI	TFT	VGA	TFT adjustment only (see Monitor Setup , page 36)
DVI	CRT	VGA	No setup required
DVI	TFT	DVI	No setup required

6.2 Setup Instructions for VGA Input

This procedure is designed to correct for discrepancies in the video signal due to analog/digital video conversion by the Extender system. You do not need to follow this procedure if you have a DVI graphics card connected to the Local unit. In this case, the video signal remains in a digital format through the Extender system.

If you are using a TFT monitor at the remote console with a VGA cable, you should carry out the Monitor Setup procedure first (see page 36). In this configuration, both the Extender AND the TFT digitize the video data stream and affect video quality. By setting up the TFT monitor, you ensure that you are correcting discrepancies due solely to the Extender system in this procedure. Alternatively, you could replace the TFT monitor with a CRT monitor while you carry out this procedure. You can then reconnect the TFT monitor and optimize its video image afterwards.

1. Download the test pattern from our web server:

This is a 'burst-pattern' (see Figure 20) - a picture with alternating, 1 pixel wide black and white, vertical stripes.

If you are unable to view the test card, display some black text on a white background. For example, you could open Notepad, maximize it to full screen, and fill the page with letter 'l's in a 12pt font. Proceed with step 3.

2. Select the burst-pattern graphic as desktop background for the PC:
From the Start menu, choose **Settings | Control Panel | Display | Backgrounds**.

Search for the downloaded burst file, using 'Search for'.

Select the tiled display option.

Your desktop should show fine black and white vertical stripes over the entire desktop.

3. Display the OSD (see page 26).

4. Select the Image menu option:

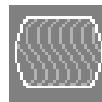

5. Select the first command icon:
Automatic detection of number of pixels per line and the best phase.



6. Assess the desktop test pattern. If the vertical stripes are sharp and without jitter or smearing, the adjustment has been successful. Go to step 10.

7. If the picture quality is not acceptable after the automatic adjustment, you will have to manually adjust the pixel clock and pixel phase (in this order).

8. With a poorly adjusted pixel clock you may see one or more vertical areas, where the lines are smeared (see Figure 21a):
 - a. Return to the OSD utility and select the menu command:
Manually adjust the number of pixels per line (Pixelclock) from the Image menu.
 - b. Adjust the pixel clock value until all stripes have disappeared.
 - c. Confirm the setting.
9. Problems with the pixel phase will cause horizontal noise, horizontal wave-formed lines, flicker or smearing with zebra-pattern (see Figure 21b):
 - a. From the OSD's Image menu, select the menu command:
Manually adjust the best phase (best point for A/D conversion within each pixel).
 - b. Modify the phase until all distortions have disappeared.
 - c. Confirm the setting.
10. If appropriate, reattach your TFT monitor and adjust its image according to the manufacturer's instructions.
11. Reinstall your preferred desktop background picture.

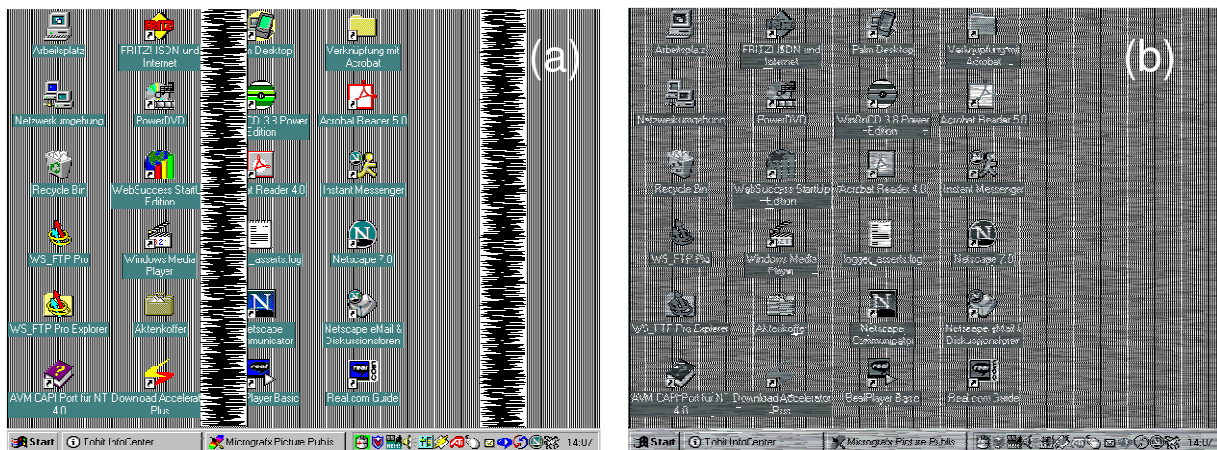

Figure 21 Burst test pattern applied to desktop showing problems with (a) pixel clock setting, (b) pixel phase setting.

7. Troubleshooting

7.1 Video

There isn't a picture.

Check the power supply connection at the Local unit. Is the *Device Ready* (Red LED) at the Local unit illuminated (see page 23)? If not, the internal power-supply may be damaged or there may be an internal error.

Check the power supply connection at the remote unit. Is the *Device Ready* (Red LED) at the Remote unit illuminated (see page 23)? If not, the internal power-supply may be damaged or there may be an internal error.

Check that the Interconnection cable is connected at the Local Unit and the Remote Unit. Is the *Link Status* LED illuminated (see page 23)? If not, there may be a problem with the Interconnection cable:

- **Fiber types:** Check that the fiber optical cable is correctly connected. The strand connected to the Local Unit's TX (left-hand connector) must run to the Remote Unit's RX (right-hand connector) and vice versa.
- **Fiber types:** There may be one or more broken fibers. Do NOT look into a fiber's end directly while it is connected to a Local or Remote unit! Are the *Link Status* LEDs at the Local Unit AND at the Remote Unit illuminated? If they are flashing, check for broken fibers using a flashlight.
- **Fiber types:** Are the cables of the recommended fiber type? If you used your own fiber optical cable (not supplied by Black Box), please ensure that you have used 50 μ or 62.5 μ fiber with a multimode device or a 9 μ fiber with a singlemode device. Other fiber-types and poly-fibers are not supported.
- **CATx types:** Check that you have wired the cable 'straight through'. 'Cross wired' cables will not work.
- **CATx types:** Check that the cable is correctly wired. Use a CATx cable tester for checking wrong wired or broken strands.

Check that you are using a supported video mode (see **Appendix D: Video Modes and Frame Rates**). At the Remote Unit, is the *Video Signal* LED illuminated (see page 23)?

Check your total system configuration. Local units digitize incoming VGA signals and must receive perfect SYNC signals: no glitches, spikes or deformed signals are allowed. Long/wrong or bad cables, or additional components like Splitters or KVM Switches may deform the SYNC signals.

Also check that the signals (level and signal form) match the VESA Standard requirements.

There is horizontal jitter on the picture.

The pixel clock and/or phase is misaligned: Refer to page 38.

Characters are smeared.

The phase is misaligned: Refer to page 38.

Thin vertical lines are missing.

The phase is misaligned: Refer to page 38.

Colored areas of the screen look like an oil film.

In some circumstances, the Extender's internal video processor may lose its firmware. In this case, it is necessary to reset the unit. A power cycle is NOT sufficient! Please use the OSD to make a **Factory Reset** (see page 33).

7.2 Keyboard & Mouse

The keyboard or mouse doesn't work.

Is there a picture? If not, check the solutions suggested in the previous section.

If the picture is OK, check that the model of mouse or keyboard is supported.

The mouse pointer doesn't move when I move the mouse.

Is the other console currently active (see **Access Switching**, page 24)? In a dual access system, the Local unit initially has control each time you boot up the system or power cycle the Remote unit. You will also observe this effect at one console when the other console has been in use.

If you want to get control at a console, you have to either press any key on the keyboard or, optionally, press the left and right mouse buttons simultaneously (this is determined by a jumper setting, see **Appendix C: System Upgrade & Dual Access**, page 48). To make a console active, we suggest you press and release one of the Shift keys since this will not affect the current PC activity.

Please note that you cannot gain control if the other console is in use or until the inactivity timeout period has expired.

Appendix A: Example Applications

This section illustrates some specific applications using Extender units:

- USB fiber with local access (Figure 22).
- CATx with audio/serial support in dual wide housing (Figure 23).
- Dual Head application with PS/2 keyboard/mouse, USB support and audio/serial in 19"/1U (Figure 24).
- 3x Dual Head application in 19"/2U (Figure 25).

For more details, please discuss suitable extension architecture with Technical Support (see **Appendix G: Calling Technical Support**).

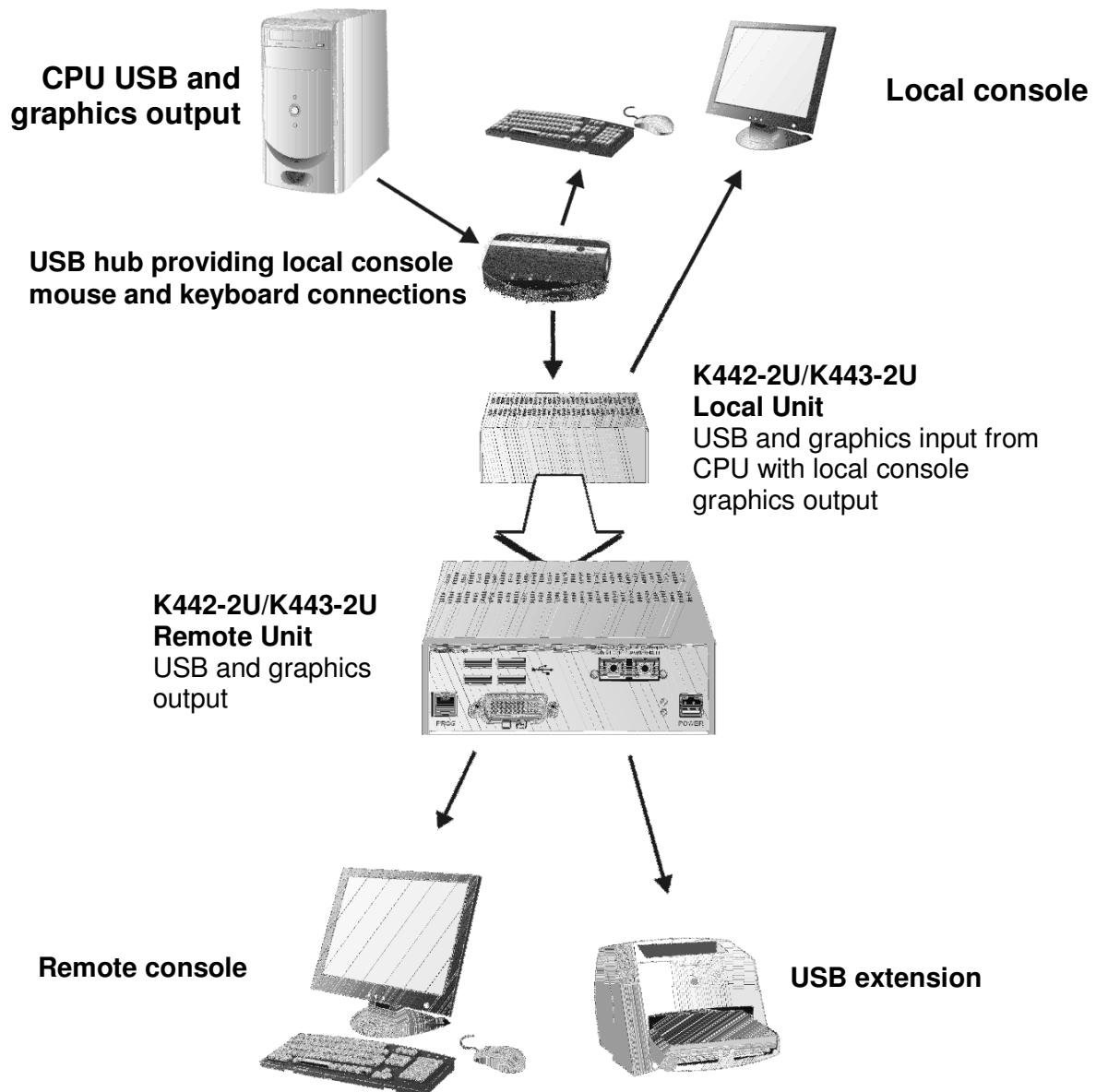

Figure 22 USB extension with local access

APPENDIX A: EXAMPLE APPLICATIONS

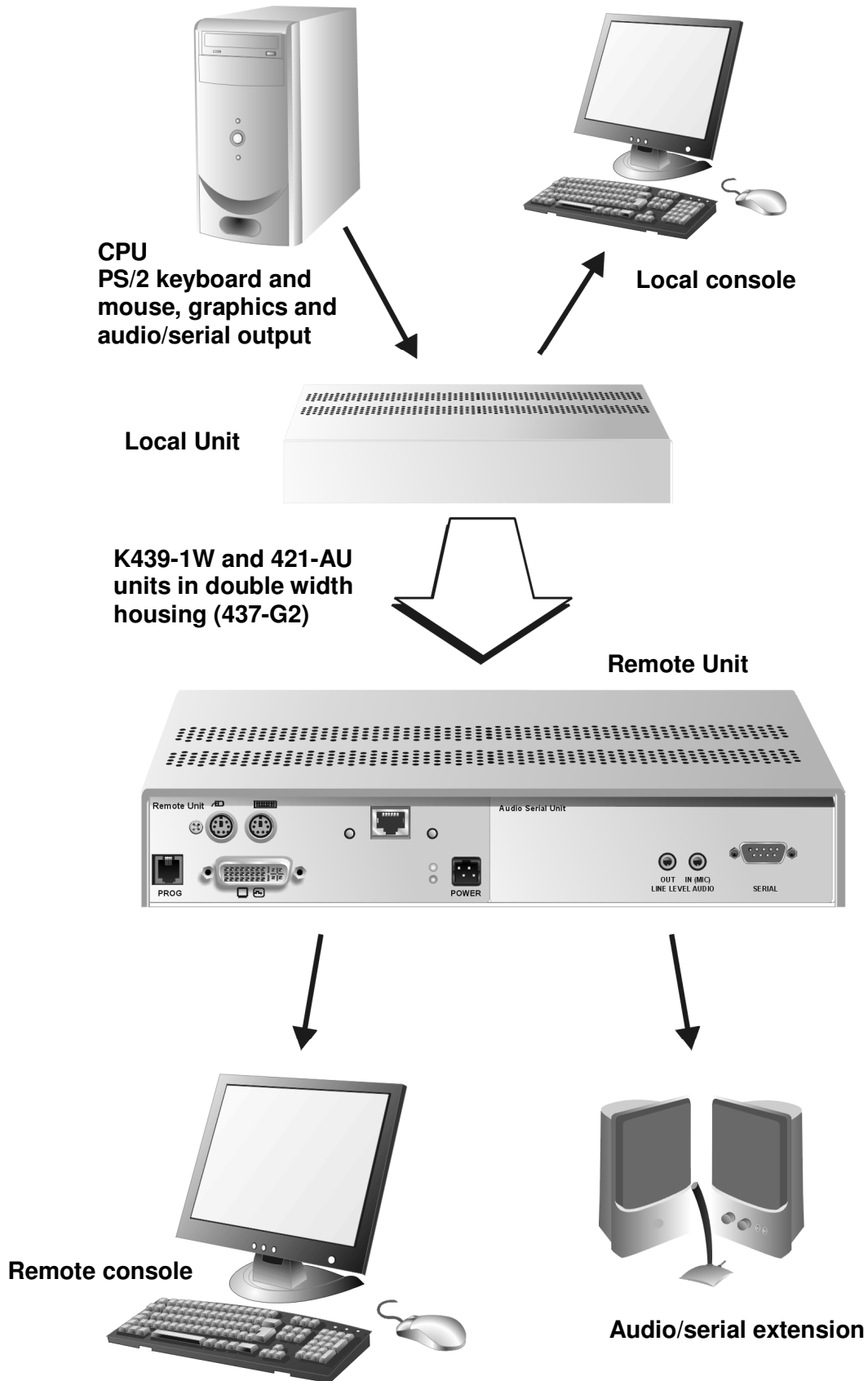

Figure 23 CATx application with local access and audio/serial extension

DDXI DVI/VGA KVM EXTENDER FAMILY

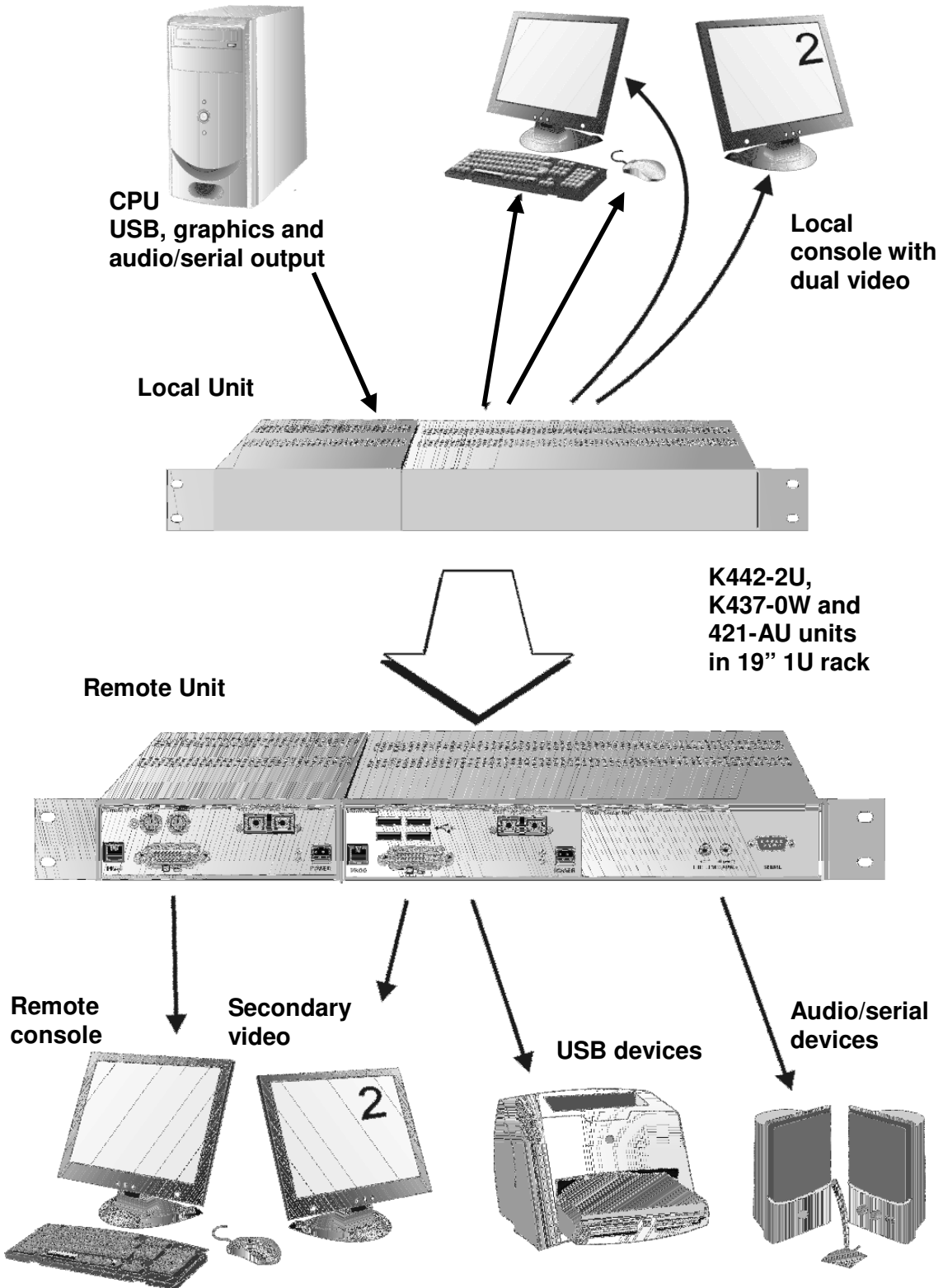

Figure 24 Dual Head application with PS/2, USB and audio/serial extension

APPENDIX A: EXAMPLE APPLICATIONS

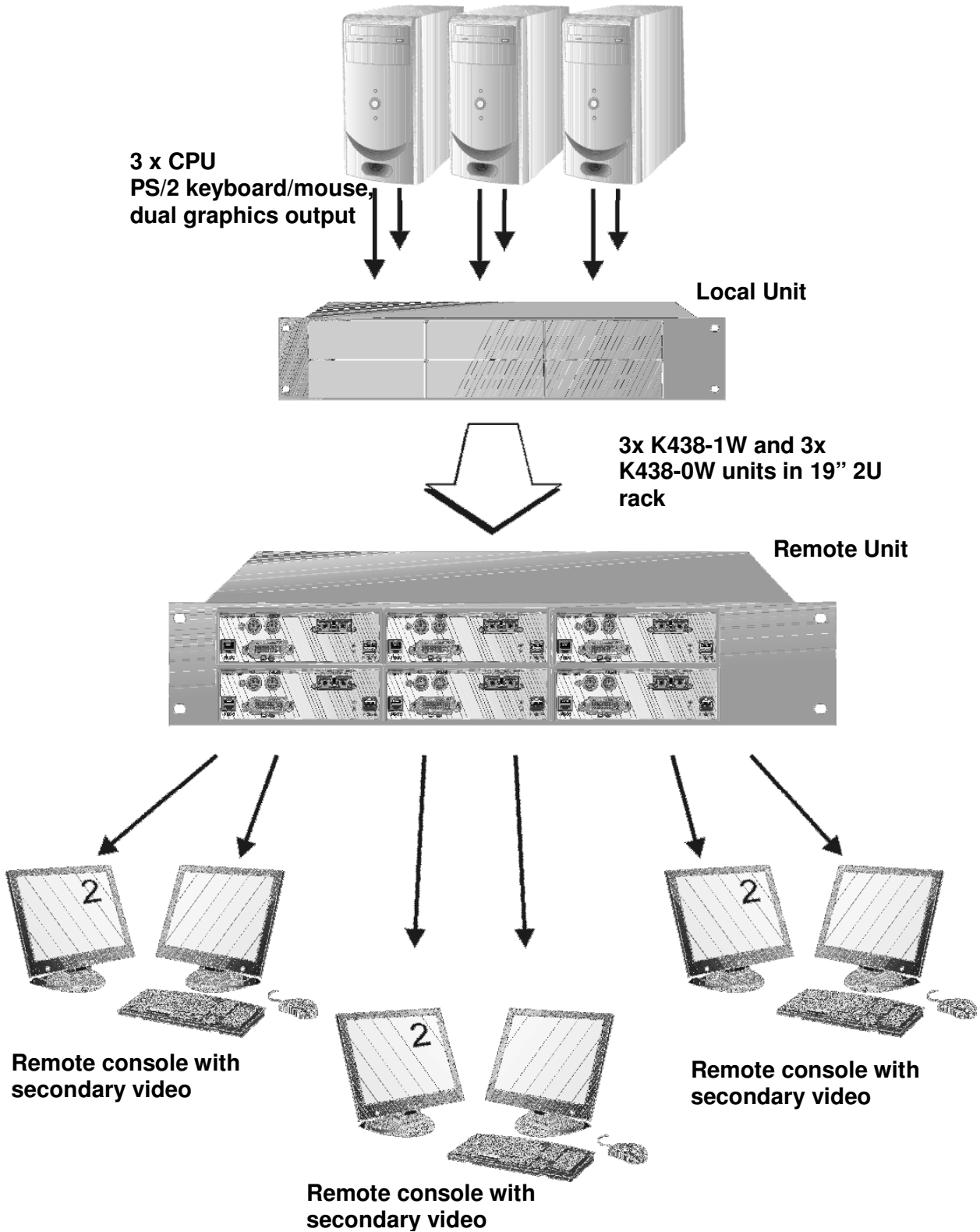

Figure 25 Multiple dual head application

Appendix B: Rack Mount Options

Extender units can be mounted in a 19" rack using the mounting kit:
DVI-KVM-Rackmount Kit

This contains the following parts:

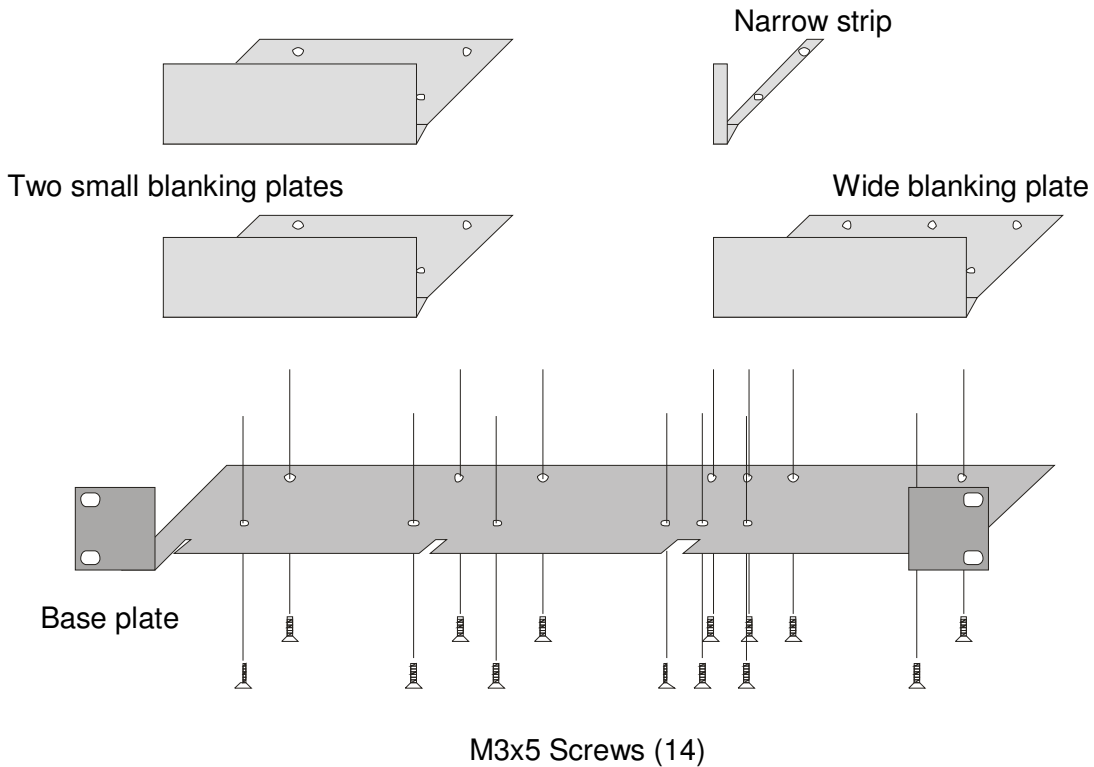

Figure 26 **Rack Mounting Kit**

To mount a unit:

1. Align the holes on the base plate with the vacant screw holes on the base of the extender unit.
2. Fasten the base of the unit to the plate of the mounting kit using the supplied screws.
3. Close the remaining gaps with blanking plates.

APPENDIX B: RACK MOUNT OPTIONS

The kit allows you to mount various combinations of regular and double width housings:

1. One regular unit (using two small plates)
2. Two regular units (using one small plate)

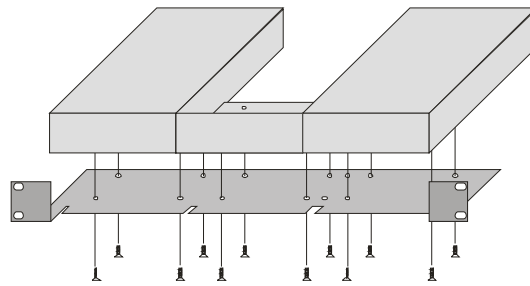
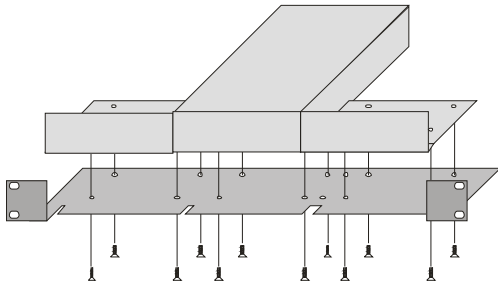

3. Mounting of three regular units

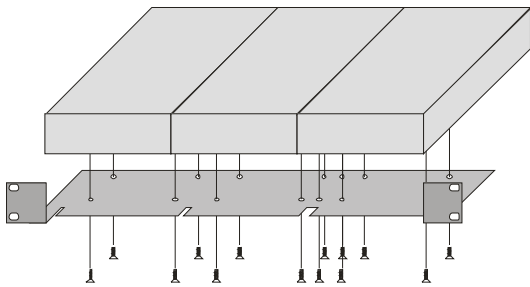

4. Mounting of one double width unit (using wide plate)

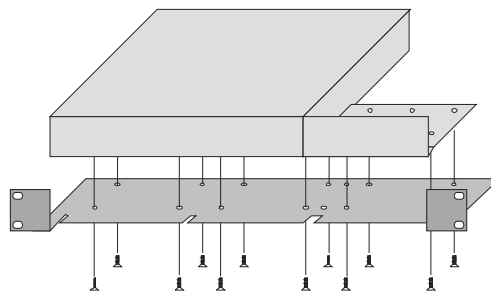

5. Mounting of double width and regular units (using narrow strip)

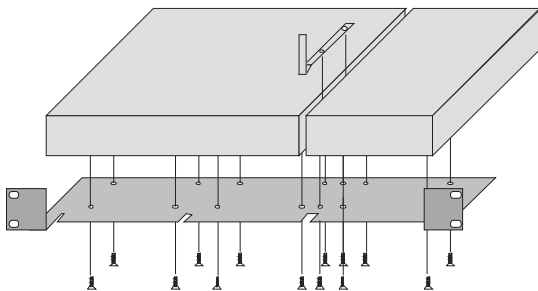

Figure 27 **Rack Mount Kit**

Appendix C: System Upgrade & Dual Access

System Update / Onboard Programming

It is occasionally necessary to update the firmware of the system. Normally, this procedure is carried out in the factory. If you want to update the firmware yourself, contact Technical Support. You will need a programming cable and software to carry out the update. Please follow the supplied instructions carefully.

Dual Access (PS/2 devices only)

Two jumpers located on the keyboard/mouse daughter board in the Remote unit allow you to:

- Change the Inactivity Timeout period between 2s (the default) and 15s. This is the minimum time of mouse and keyboard inactivity required at one console, before the Extender system allows the user at the other console to gain control.

The upper jumper switch (labeled *Time*) selects the inactivity timeout period. When closed, the setting is 2 seconds. When open, the setting is 15 seconds.

- Select the method for gaining control. Two choices are available:
 - Any keyboard activity or by pressing the left and right mouse buttons simultaneously (the default), or
 - Keyboard activity only.

The lower jumper switch (labeled *KeyB*) selects the method of switching between local and remote consoles. When open, the setting is for any keyboard action or by pressing the left and right mouse button simultaneously. When closed, the method is set to keyboard activity only.

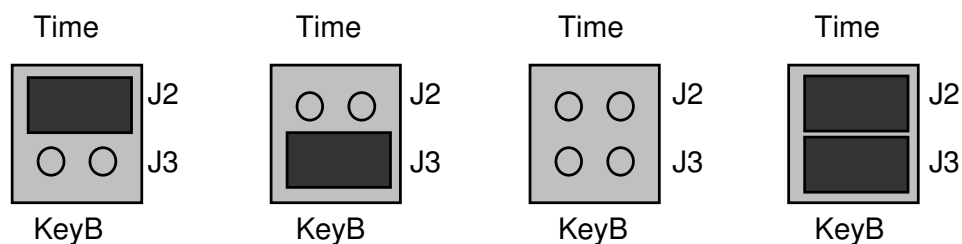

<i>Inactivity Timeout (s)</i>	15	2	2	15
<i>Keyboard/ Mouse action?</i>	K&M	K	K&M (factory default)	K

Figure 28 Alternative jumper settings for dual access control

Appendix D: Video Modes and Frame Rates

The following table shows the video modes supported by the DDXI DVI/VGA KVM Extender series and the expected frame rates (in brackets the frame rates using a 2.5Gbit module) over fiber and CATx interconnects at both high color (hiCol) and low color (loCol) settings. The Extenders are able to synchronize video modes that do not differ by more than 10% from those listed below.

Video Mode	Visible Resolution		Clock Rates			Frame Rate Fiber		Frame Rate CATx	
	Pixel s	Lines	Horiz kHz	Vert. Hz	Dot Clock MHz	Hi Col	Lo Col	Hi Col	Lo Col
DOS graphic Mode	640	350	70	31,5	25,2	70	70	70	70
Vesa Standard	640	350	85	37,9	31,5	85	85	85	85
VGA	640	400	56	24,7	20,9	56	56	56	56
VGA	640	400	70	31,4	25,1	70	70	70	70
Vesa Standard	640	400	85	37,9	31,5	85	85	43	85
Vesa Standard	640	480	60	31,5	25,2	60	60	60	60
Mac Mode	640	480	67	35,0	31,4	67	67	67	67
Vesa Standard	640	480	72	37,9	31,5	72	72	36	72
Vesa Standard	640	480	75	37,5	31,5	75	75	38	75
Vesa Standard	640	480	85	43,3	36,0	85	85	43	85
DOS Text Mode	720	400	70	31,5	28,4	70	70	70	70
Vesa Standard	720	400	85	37,9	35,5	85	85	43	85
NTSC progressive	720	480	60	31,5	27,0	60	60	60	60
PAL progressive	720	576	50	31,3	27,0	50	50	50	50
Vesa Standard	800	600	56	35,2	36,0	56	56	28	56
Vesa Standard	800	600	60	37,9	40,0	60	60	30	60
Vesa Standard	800	600	72	48,1	50,0	36 (72)	72 (72)	36	36
Vesa Standard	800	600	75	46,9	49,5	38 (75)	75 (75)	38	38
Vesa Standard	800	600	85	53,7	56,3	43 (85)	85 (85)	43	43
Mac Mode	832	624	75	49,7	55,7	38 (75)	75 (75)	38	38
Vesa Standard	1024	768	60	48,4	65,0	30 (60)	30 (60)	20	30
Vesa Standard	1024	768	70	56,5	75,0	35 (70)	35 (70)	23	35
SUN Mode	1024	768	72	57,8	74,9	36 (72)	36 (72)	24	36
Vesa Standard	1024	768	75	60,0	78,8	38 (75)	38 (75)	25	38
Vesa Standard	1024	768	85	68,7	94,5	28 (42)	42 (85)	21	28
DMT1185 Mode	1152	864	70	63,8	100,5	23 (35)	35 (70)	18	23
Vesa Standard	1152	864	75	67,5	108,0	25 (38)	38 (75)	19	25
SUN Mode	1152	900	66	61,8	94,4	22 (33)	33 (66)	17	22
Vesa Standard	1280	960	60	60,0	108,0	20 (30)	30 (60)	15	20
DMT127A	1280	960	75	75	126,0	25 (38)	25 (38)	15	25
Vesa Standard	1280	960	85	85,9	148,5	21 (43)	28 (43)	17	21
Vesa Standard	1280	1024	60	64,0	108,0	20 (30)	30 (60)	15	20
SUN mode	1280	1024	66	71,7	117,0	22 (33)	33	17	22
SGI	1280	1024	72	76,7	128,8	24 (36)	24 (36)	14	24
HP Workstation B123L	1280	1024	72	78,1	135,0	24 (36)	24 (36)	14	24
Vesa Standard	1280	1024	75	80,0	135,0	25 (38)	25 (38)	15	19
Vesa Standard	1280	1024	85	91,1	157,5	21 (43)	28 (43)	14	21
TV Mode	1280	768	60	48,1	81,2	30	30	20	30
Vesa CVT 16:9	1280	720	60	44,8	74,5	(60)	(60)	--	--
WXGA	1280	768	60	48,1	81,2	(60)	(60)	--	--
WXGA	1280	768	60	47,8	80,0	(60)	(60)	--	--
TV	1280	1024	50	53,4	90,0	(25)	(50)	--	--
TV Mode 16:9	1360	765	60	47,6	84,5	(30)	(60)	--	--

DDXI DVI/VGA KVM EXTENDER FAMILY

Plasma TV16:9	1360	768	60	47,7	85,5	(30)	(60)	--	--
NVIDIA 4:3	1400	1050	60	65,2	121,5	(30)	(30)	--	--
Linux 4:3	1400	1050	60	64,9	122,0	20	30	15	20
SGI	1600	1024	72	77,6	158,3	18 (36)	24 (36)	12	18
Vesa Standard	1600	1200	60	75,0	162,0	15 (30)	20 (30)	10	15
TV Mode 16:9	1600	900	60	55,8	118,8	(30)	(30)	--	--
UXGA genlocked	1600	1200	50	75,0	138,0	(25)	(25)	--	--
UXGA reduced blank.	1600	1200	60	75,0	162,0	(30)	(30)	--	--
TV Mode 16:10	1680	1050	60	65,3	146,2	(30)	(30)	--	--
TV Mode 16:9	1920	1080	50	56,4	148,5	--	(25)	--	--
TV Mode 16:9 reduced blank.	1920	1080	60	66,6	138,5	--	(30)	--	--
EIA861B 16:9	1920	1080	60	67,5	148,4	--	(30)	--	--
WUXGA	1920	1200	60	74,0	154,0	--	(30)	--	--

Frame Rates (FPS)

A DDXI DVI/VGA KVM Extender is not capable of transferring every frame generated by a graphics card because the net data rate of a Single Link DVI-Interface with 3.5Gbit is much higher than the available transfer rate of the Extenders.

Transmission follows the following scheme:

- Starting with a recognized VS-Signal, the first frame is digitized (on VGA) and temporarily stored (DVI+VGA) by the Local unit.
- The data are transmitted, using the available net data rate, to the Remote unit. During this time, frames generated by the graphic card are discarded without any recognition (frame dropping).
- When data transfer is complete, the Extender system waits for the next VS-Signal.

Depending on the data volume (affected by the selected screen resolution/refresh rate), the type of transmission module and the correspondence between the duration of the data transfer and a multiple of the refresh rate, you should get frame rates in a range of approximately 15 fps up to the actual refresh rate of the graphic card.



The frame rate counts the number of different pictures that are displayed in one second. The monitor is always driven with the same refresh rate as generated by the graphics card or selected in the OSD.

The human eye is not able to discern more than 15 fps as single pictures. Your DDXI DVI/VGA KVM Extender is therefore suitable for displaying streaming video in the highest resolution. To gain a higher frame rate, reduce the screen resolution - video normally does not require higher resolutions.



In higher resolution, the mouse pointer may show broken movement over the screen because of the reduced frame rate. Use slower mouse movements for exact positioning.

Appendix E: USB – High Power/Low Power



The USB specification allows low power and high power devices to be attached to, and powered through, the USB hub. Power consumption may exceed the internal power capabilities of the Extender if you attach more than one high power device to the Remote Unit hub. In such cases, you are recommended to use the supplied PSU for powering the USB hub.

The USB specifications allow:

- 100mA for low power devices
- 500mA for high power devices

The DVI-KVM-U-xx can supply up to 500mA. There is no total power limitation, so consuming more than 500mA may overload the internal power supply and shutdown the device. This means, you can attach either:

- 1 to 4 low power units **or**
- 1 high power unit

If your total USB power consumption exceeds 500mA, you need to connect the supplied PSU before attaching the devices.

Using the power supply unit, you may attach:

- 1 to 4 high power units **or**
- 1 to 4 low power units **or**
- Any combination of these

Each port has a regulated power limit of 500mA.

Appendix F: Audio/Serial Upgrade

The Audio/Serial Upgrade option consists of daughter boards that allow bi-directional stereo audio and a full-duplex serial data link to be sent across the regular interconnection cable in addition to keyboard, mouse and VGA/DVI video.

To set up the extender's audio and serial link, please follow all of the instructions detailed in this appendix. If you have any questions, contact Technical Support.

Serial Interface - Set Up and Operation

No setting up or user adjustments are required. Please note that on the Dual Access model, the serial link is always active.

Please bear in mind that the Remote Unit's serial port is wired as DTE (i.e. the same as that on a PC). To connect a serial printer (or other DTE rather than DCE device) to the Remote Unit, you will need a Null-Modem (crossover) cable between the Remote Unit and the printer.

A serial touch screen may be plugged directly into the Remote Unit.

Serial Interface - Handling Multiple Serial Devices

The extender's serial interface transmits/receives six signals (3 signals in each direction). Normally four of these signals are used for hardware handshaking (in addition to TX & RX). However, because each handshaking line can support signals up to 19,200 Baud it is possible to configure the serial interface to handle up to three simple 2-wire (Tx/Rx only) serial links. Select Xon/Xoff software flow control on the remote device and PC.

To do this you will need to construct a custom breakout cable. Please contact technical support for further information.

Audio Interface - Set Up and Operation

The audio interface is line-level and is designed to take the output from a sound card (or other line-level) source and be connected to a set of powered speakers at the other end of the link. Stereo audio may be transmitted either way across the link (simultaneously). No set up is required unless a microphone is connected to the remote unit.

Connect up the extender as follows:

Take the line-level output from your sound card (green connector) and connect to 'Line In' on the extender.

A set of powered speakers may be connected directly to 'Line Out' at the opposite end of the link.

Audio Interface - Using a Microphone

A microphone may be plugged into the 'Line In' connector on the Remote Unit.

There are two ways of setting up a microphone:

- The Local Unit's 'Line Out' connection should normally be wired to the microphone input (Red) on your sound card. The sound card should then be set up to provide additional amplification (+20dB). This is the preferred connection method.
- Alternatively, the Remote Unit itself can provide microphone amplification. To set this, open up the Remote Unit and locate the jumper labeled 'MIC' on the daughter board. Connect this jumper across the pins. The Local Unit's 'Line Out' connection should then be wired to 'Line In' (Blue) on your sound card.

If your microphone is already amplified, follow the second method but DO NOT install the amplification jumper in the Remote Unit.

Appendix G: Calling Technical Support

If you determine that your DDXI DVI/VGA KVM Extender is malfunctioning, **do not attempt to alter or repair it**. It contains no user-serviceable parts. Contact Technical Support at.

Before you do, make a record of the history of the problem. We will be able to provide more efficient and accurate assistance if you have a complete description, including:

- The firmware-revision level printed on the bottom of the Extender (very important, especially for keyboard and mouse problems); The DDXI DVI/VGA KVM Extender's firmware revision level:

Version Number Format:

Board: *xxLO/RE Myyy Pzzz Auuu Gvvvvvv*
Transceiver: *C/M/S xx Pyy Mzz*
Keyboard/Mouse: *P/U xx Vyyy*

- The nature and duration of the problem.
- When the problem occurs.
- The components involved in the problem—that is, what type of computers, what type of keyboard, brand of mouse, make and model of monitor, type and make of cable, etc.
- Any particular application that, when used, appears to create the problem or make it worse.
- The results of any testing you've already done.

To solve some problems, it might be necessary to upgrade the Extender's firmware. If this turns out to be the case for your difficulty, our Technical Support technicians will arrange for you to receive the new firmware and will tell you how to install it.

Shipping and Packaging

If you need to transport or ship your DDXI DVI/VGA KVM Extender:

- Package it carefully. We recommend that you use the original container.
- If you are shipping it for repair, please include the Unit's external power supplies. If you are returning it, please include everything you received with it. Before you ship the Extender back to your dealer for repair or return, contact him to get a Return Authorization (RA) number.

Appendix H: Specifications

Power Requirements

Voltage	PSU: 90..240VAC-0.5A-47..63Hz/ 6VDC-2000 mA
Power required	Local Unit: approx. 8W Remote Unit without keyboard: approx. 8W Remote Unit with keyboard: approx. 9.5W
Voltage	PSU: 90..240VAC-0.5A-47..63Hz/5VDC-2400 mA
Power required	Remote Unit USB port with multiple high power devices, bus powered: approx. 10W

Interface

(Depending on type of device)

Monitor	VGA (res.: 1600x1200@60Hz, plug&play supported) all lower resolutions at least with 75Hz DVI (res.: 1600x1200@60Hz, plug&play supported)
Local Access	max. resolution DVI: 1600x1200, VGA: 1280x1024 output depends on input type VGA or DVI
Keyboard/Mouse	IBM PS/2 (power consumption <100mA)
USB	USB 1.1 compatible (NO CD-Writer!)
USB-Remote	4 port Hub - low power (max 100mA each) or 1x high power (max 500mA) without PSU. - high power (max 500mA each) with additional PSU.

Maximum Length of Interconnection Cable

(Without reboost)

CAT5/5e/6	330ft (100m) with solid trunk cable 200ft (60m) with stranded cable
62.5µm/50µm Multimode	650ft (200m) @62,5µ 1300ft (400m) @50µ
9µm Singlemode	6 ¼ miles (10km)

DDXI DVI/VGA KVM EXTENDER FAMILY

Type of Interconnection Cable

<i>CATx Installation cable AWG24</i>	S/UTP (Cat5) cable acc. EIA/TIA 56A, TSB 36 or Digital STP 17-03170. Four pairs AWG 24. Wiring acc. EIA/TIA 568A (10BaseT).
<i>CATx Patchcable AWG26/7</i>	S/UTP (Cat5) cable acc. EIA/TIA 56A, TSB 36 or Digital STP 17-03170. Four pairs AWG 26/8. Wiring acc. EIA/TIA 568A (10BaseT).
<i>Singlemode 9 μm</i>	Two fibres 9 μ m. E.g. I-V (ZN)H 2E9 (In house patch cable) or I-V(ZN)HH 2E9 (In house Breakout cable) or I/AD(ZN)H 4E9 (in house OR outdoor Breakout cable, stress resistant) or A/DQ(ZN)B2Y 4G9 (outdoor cable, stress resistant with protection against animal biting) All notations acc. VDE specification.
<i>Multimode 50μm</i>	Two fibres 50 μ m, E.g. I-V(ZN)H 2G50 (In house patch cable) or I/AD(ZN)H 4G50 (in house OR outdoor Breakout cable, stress resistant) All notations acc. VDE specification.
<i>Multimode 62.5μm</i>	Two fibres 62.5 μ m. E.g. I-V(ZN)HH 2G62,5 (In house Breakout cable) or A/DQ(ZN)B2Y 4G62,5 (outdoor cable, stress resistant with protection against animal biting) All notations acc. VDE specification.

APPENDIX H: SPECIFICATIONS

Serial Interface

(Available with Serial/Audio Upgrade option only)

Serial Speed	Up to a maximum of 19,200 Baud
Serial Data Format	Format Independent
Flow Control	RTS, CTS, DTR, DSR are sent across link

Audio Interface

(Available with Serial/Audio Upgrade option only)

Description	Bi-directional stereo audio link
Transmission Method	Digitized virtually CD quality audio (16-bit, 38.4KHz)
Signal Levels	Line-Level (5 Volts Pk-Pk maximum)
Input Impedance	47K
Local Unit Connectors	2 x 3.5mm stereo jack socket (Line In & Line Out)
Remote Unit Connectors	2 x 3.5mm stereo jack socket (Line/Mic In & Line Out)
Microphone Support	A microphone may be connected to the Remote Unit. Pullup resistor provides bias for condenser microphone. Option to set microphone amplification to +17dB.

Size and Shipping Weight

Remote and Local Unit	Remote/Local Unit: 6.7"x5.2"x1.7" (170x133x44mm) Weight: 2.2lb (1.0kg) each
Shipping box	Shipping Box: 18.1"x9.8"x4.7" (460x250x120mm) Weight: 9.5lb (4.3kg)

Environmental

Operating Temperature	41 to 113°F (5 to 45 °C)
Storage Temperature	-13 to 140°F (-25 to 60 °C)
Relative Humidity	max. 80% non-condensing

Appendix I: Connectors and Cables

Extender Connector Pinouts

DVI-I Female connector (on all units)

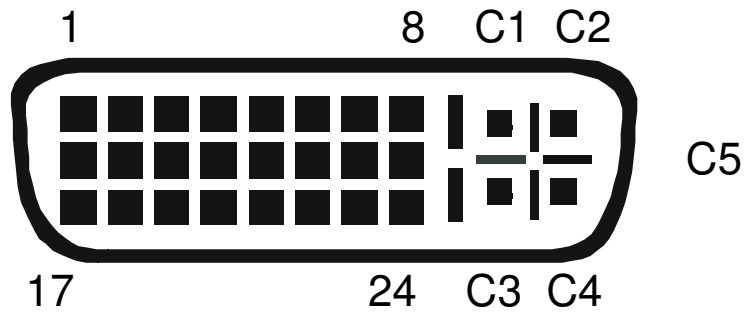

<i>Pin</i>	<i>Signal</i>	<i>Pin</i>	<i>Signal</i>	<i>Pin</i>	<i>Signal</i>
1	T.M.D.S data 2-	9	T.M.D.S data 1-	17	T.M.D.S data 0-
2	T.M.D.S data 2+	10	T.M.D.S data 1+	18	T.M.D.S data 0+
3	T.M.D.S data 2 GND	11	T.M.D.S data 1 GND	19	T.M.D.S data 0 GND
4	n.c.	12	n.c.	20	n.c.
5	n.c.	13	n.c.	21	n.c.
6	DDC Input (SCL)	14	+5V Power	22	T.M.D.S clock GND
7	DDC Output(SDA)	15	GND	23	T.M.D.S clock +
8	Analog VSYNC	16	Hot Plug recognition	24	T.M.D.S clock -
C1	Analog Red			C3	Analog Blue
C2	Analog Green	C5	Analog GND	C4	Analog HYSNC

Mouse In/Out



6 pin miniDIN female

<i>Pin</i>	<i>Signal</i>
1	MOUSE DATA
2	n.c.
3	GND
4	+5V
5	MOUSE CLOCK
6	n.c.

Keyboard In/Out



6 pin miniDIN female

<i>Pin</i>	<i>Signal</i>
1	KEYBOARD DATA
2	n.c.
3	GND
4	+5V
5	KEYBOARD CLOCK
6	n.c.

DDXI DVI/VGA KVM EXTENDER FAMILY

Programming

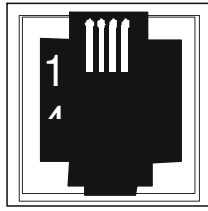

<i>Pin</i>	<i>Signal</i>
1	TxD (to PC RxD)
2	RxD (from PC TxD)
3	DTR from PC
4	GND

Power

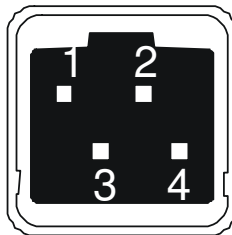

<i>Pin</i>	<i>Signal</i>
1	GND
2	Earth
3	n.c.
4	+6VDC
Housing	Shield

Adapter Cables

DVI/VGA Adapter

Remote/Local Unit: DVI-I male connector

Monitor: HD15 female

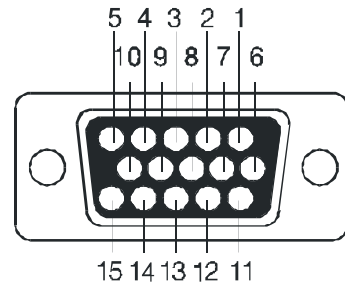
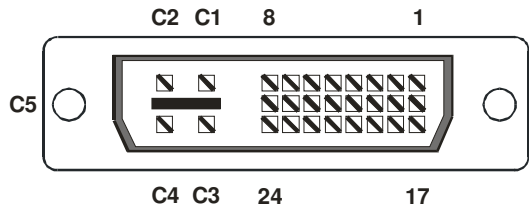

Pin	Signal
6	DDC Input (SCL)
7	DDC Output(SDA)
8	Analog VSYNC
C1	Analog Red
C2	Analog Green
C3	Analog Blue
C4	Analog HYSNC
C5	Analog GND

Pin	Signal
15	DDC Input (SCL)
12	DDC Output (SDA)
14	Analog VSYNC
1	Analog Red
2	Analog Green
3	Analog Blue
13	Analog HSYNC
6,7,8	Analog GND

DDXI DVI/VGA KVM EXTENDER FAMILY

Local unit VGA/DVI Adapter

CPU Graphics card: HD15 male connector

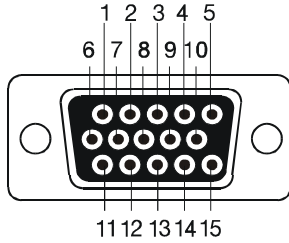

<i>Pin</i>	<i>Signal</i>
15	DDC Input (SCL)
12	DDC Output (SDA)
14	Analog VSYNC
1	Analog Red
2	Analog Green
3	Analog Blue
13	Analog HSYNC
6,7,8	Analog GND

Local Unit: DVI-I male connector

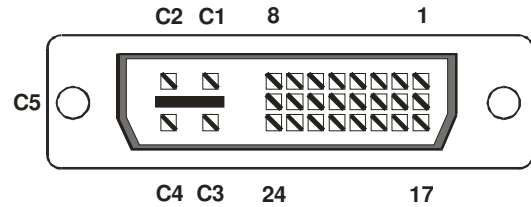

<i>Pin</i>	<i>Signal</i>
6	DDC Input (SCL)
7	DDC Output (SDA)
8	Analog VSYNC
C1	Analog Red
C2	Analog Green
C3	Analog Blue
C4	Analog HSYNC
C5	Analog GND

CATx Cable and Connector

